



Муниципальное бюджетное учреждение  
дополнительного образования  
« Дом детского творчества » муниципального образования  
« Лениногорский муниципальный район »  
Республики Татарстан

РАССМОТРЕНО:  
на методическом совете  
МБУДО «ДДТ» МО «ЛИМР» РТ  
Протокол № 8 от « 19 » мая 2020 г.

УТВЕРЖДАЮ:  
Директор МБУДО  
« Дом детского творчества »  
МО «ЛИМР» РТ

Е.М. Семёнова



# Методическое пособие

# Рабочая тетрадь

# I год обучения

**Автор-составитель:**  
педагог дополнительного образования  
I квалификационной категории  
Макарычева Зульфия Ахсановна

г. Лениногорск, 2020



Учебная тетрадь к дополнительной общеобразовательной общеразвивающей программе естественнонаучного направления по обучению английскому языку «Английский для каждого» разработана для учащихся первого года обучения и является вспомогательным и увлекательным материалом для работы. Яркие красочные картинки позволяют детям эффективнее запоминать изученную лексику. Кроме самоконтроля, тетрадь используется для различных игр и отработки лексических единиц. По каждой представленной теме разработаны дидактические карточки (с точно такими же картинками, что и в тетради), с помощью которых и вводится лексика.

# 1.Английский алфавит

A

B

C

D

E

F

G

H

I

J

K

L

M

N

O

P

Q

R

S

T

U

V

W

X

Y

Z

# Finish the alphabet.

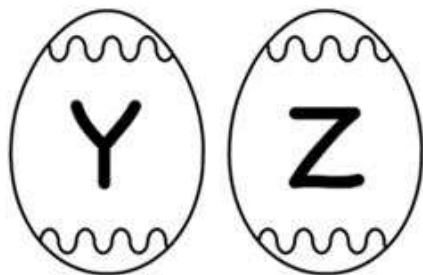
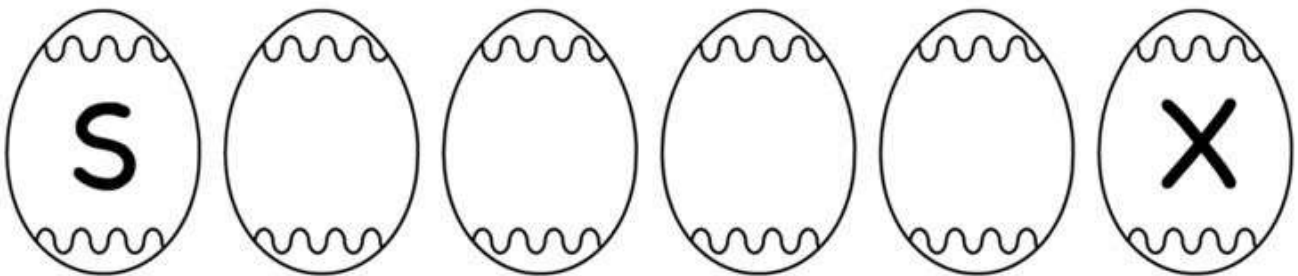
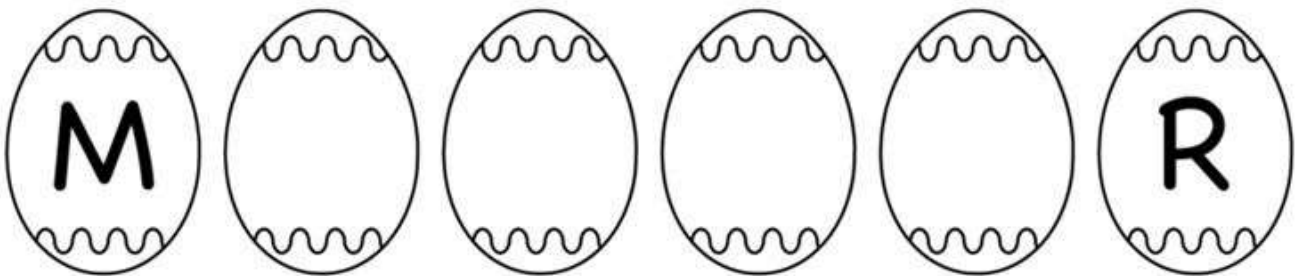
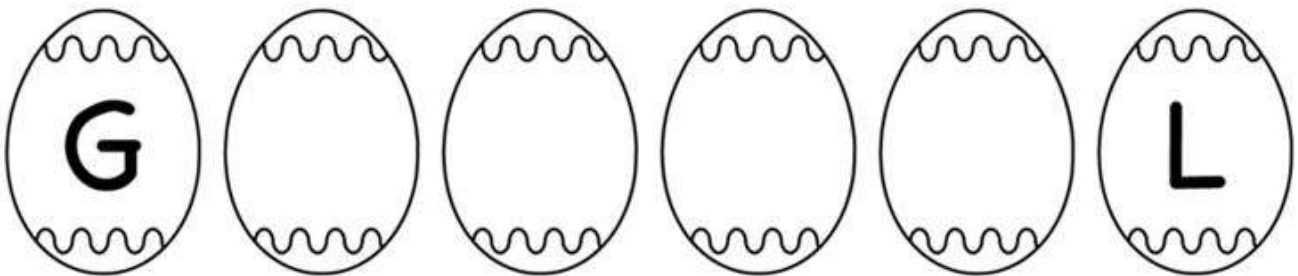
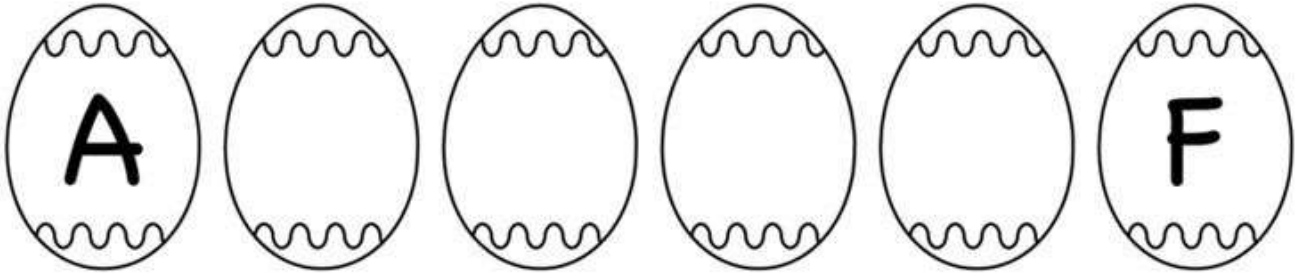

A

B

C

D

E

F

G

H

I

J

K

L

M

N

O

P

Q

R

S

T

U

V

W

X

Y

Z

**Aa**

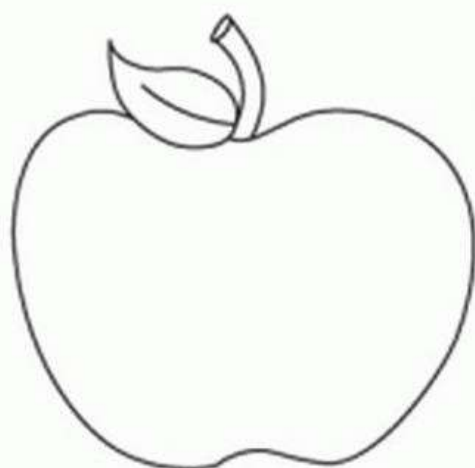

**Apple**

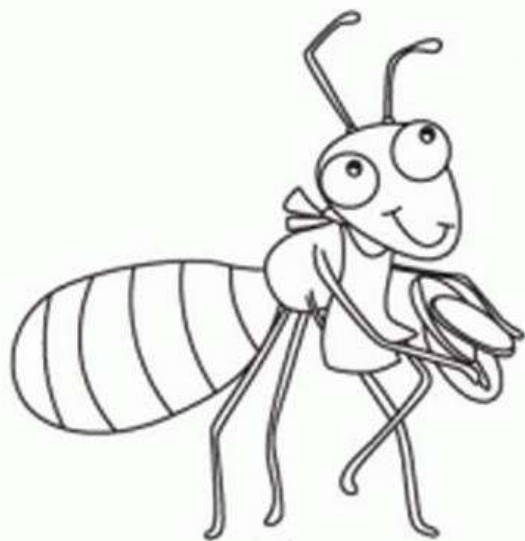

**Ant**



**Archer**

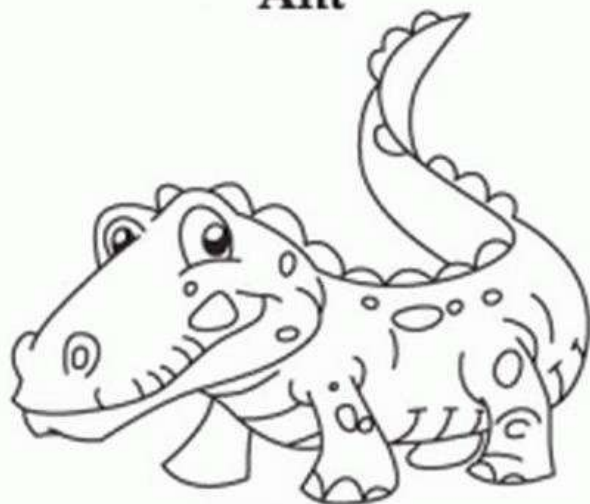

**Alligator**

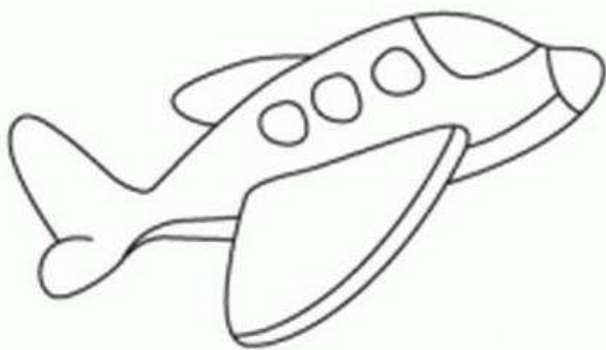

**Airplane**



Mm

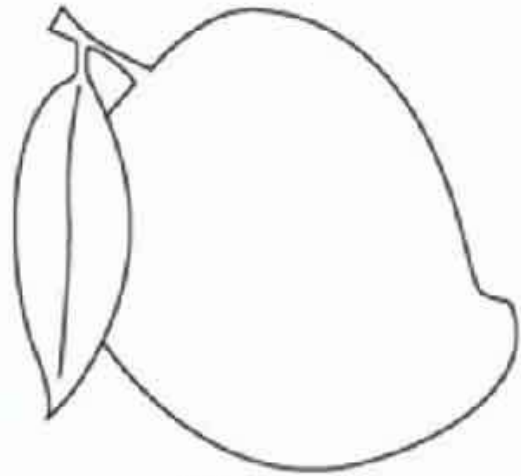

Mango



Monkey

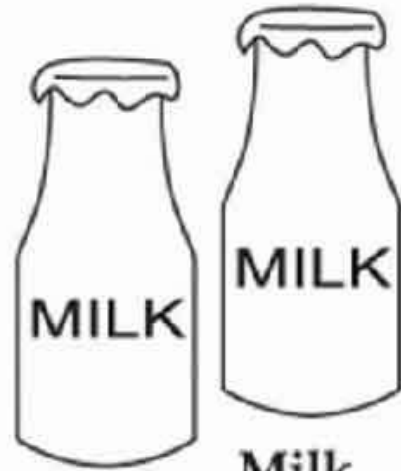

Milk



Moon

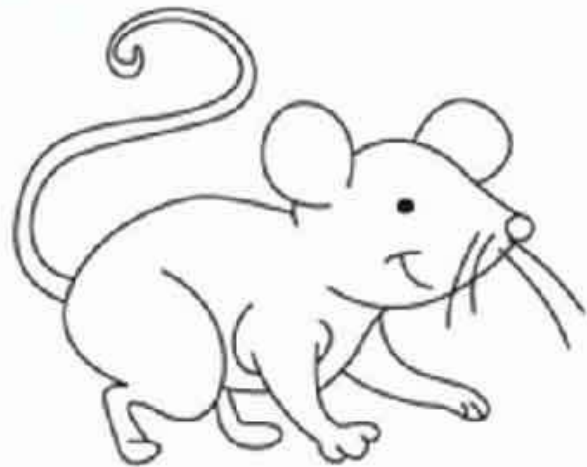

Mouse

**Tt**



**Tiger**

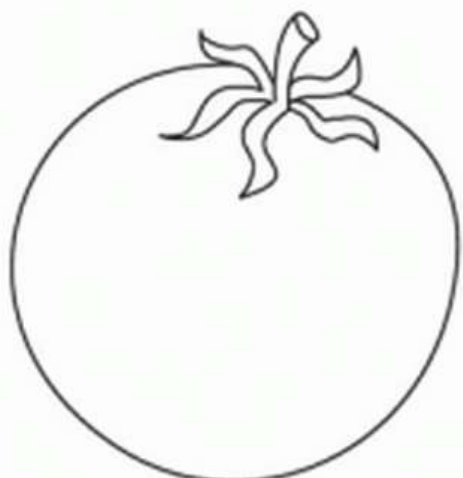

**Tomato**

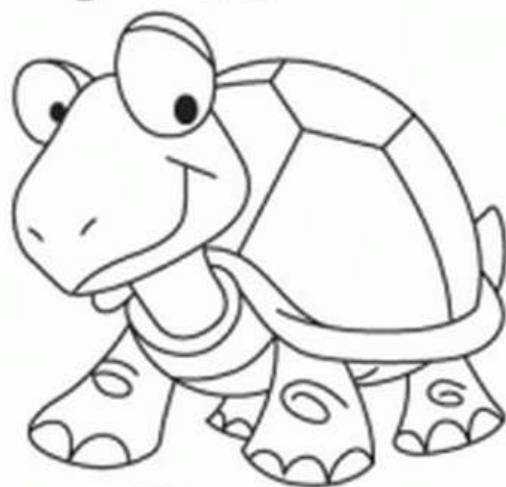

**Tortoise**

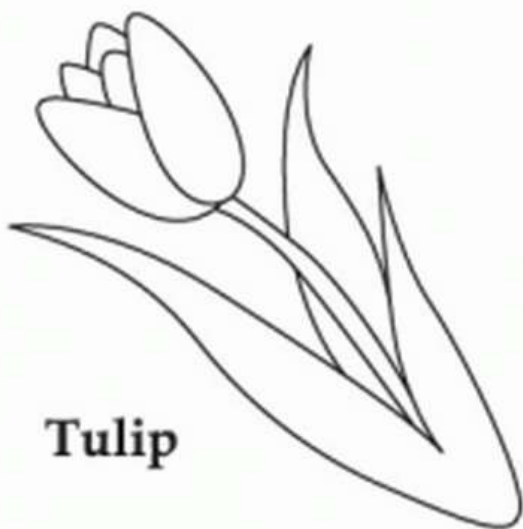

**Tulip**



**Top**



Cc



Cow

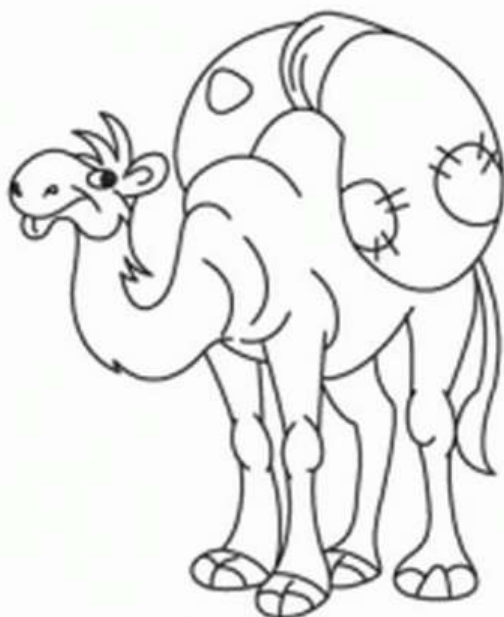

Camel



Cat



Car

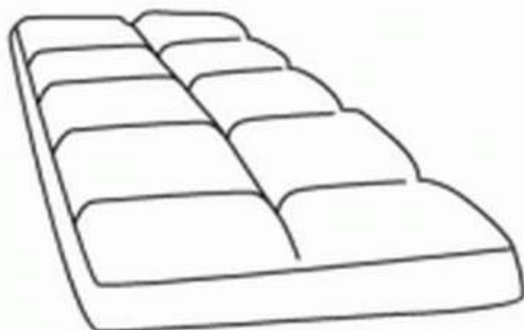

Chocolate

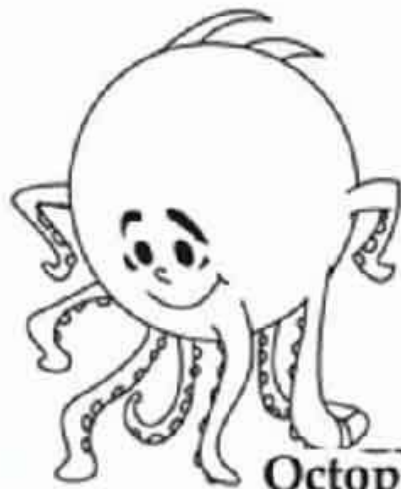

**Octopus**



**Ostrich**



**Orange**



**Owl**

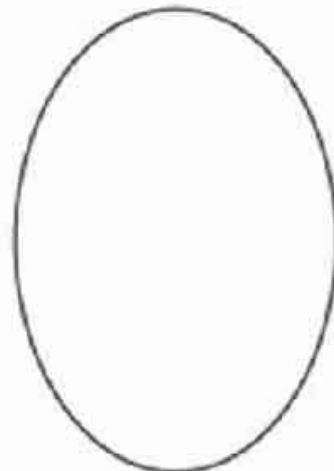

**Oval**

Pp



**Papaya**

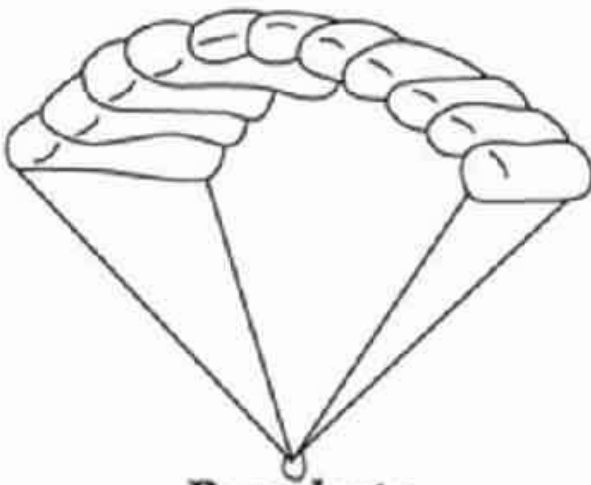

**Parachute**

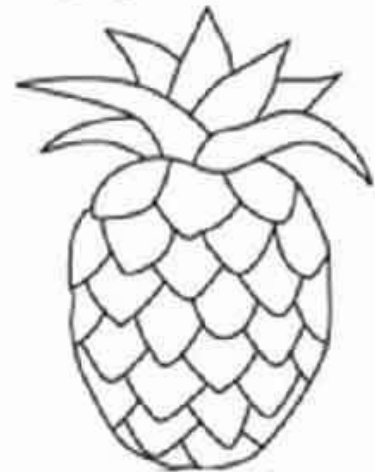

**Pineapple**

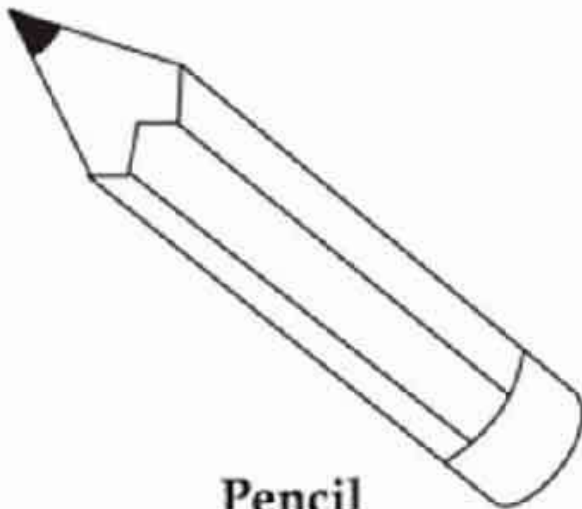

**Pencil**



**Panda**

Y y



Yo-yo

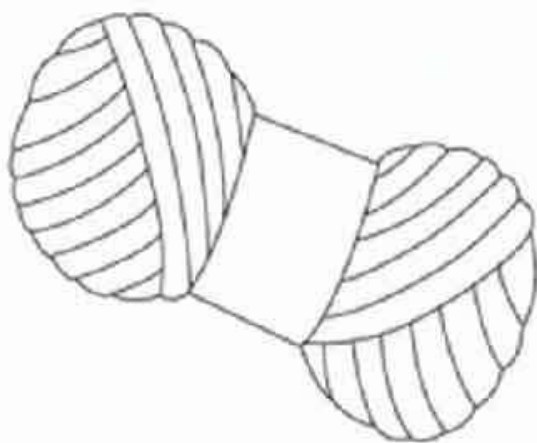

Yarn



Yacht



Yak

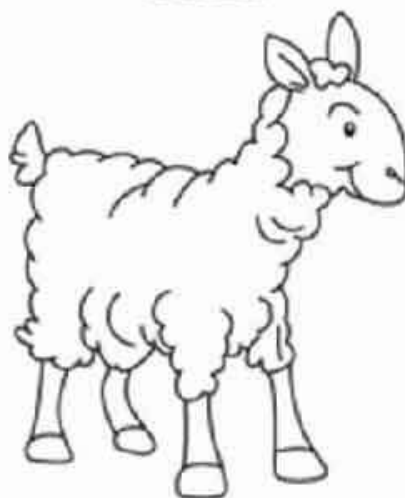

Yeanling

Zz



Zebra

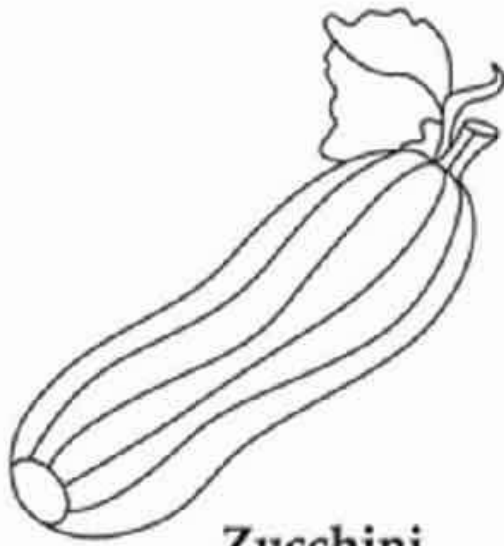

Zucchini



Zinnia

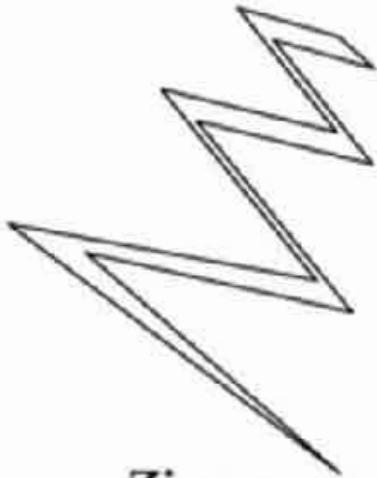

Zigzag

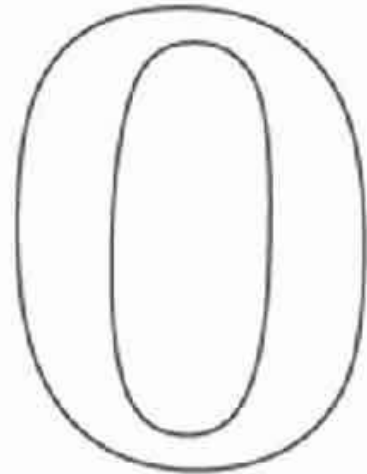

Zero



J j

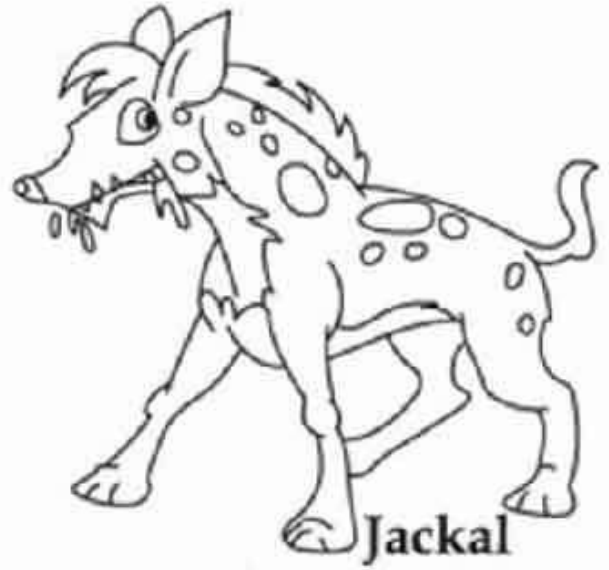

Jackal



Juggler



Jump



Jug



Jeep



Gg

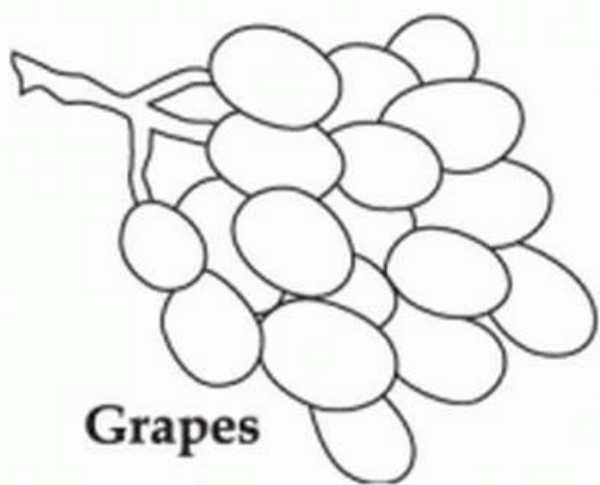

Grapes



Giraffe



Grasshopper



Gorilla

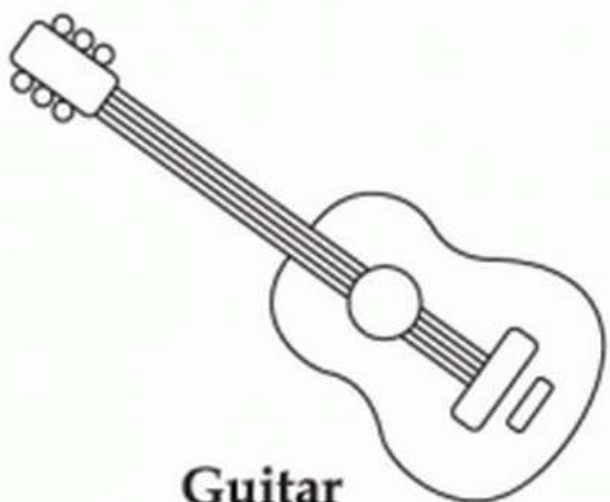

Guitar

**Ff**



**Fish**



**Fox**

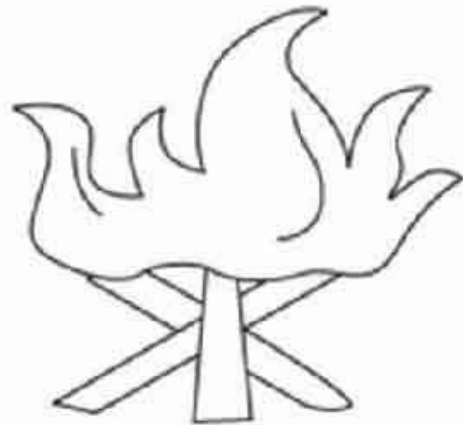

**Fire**

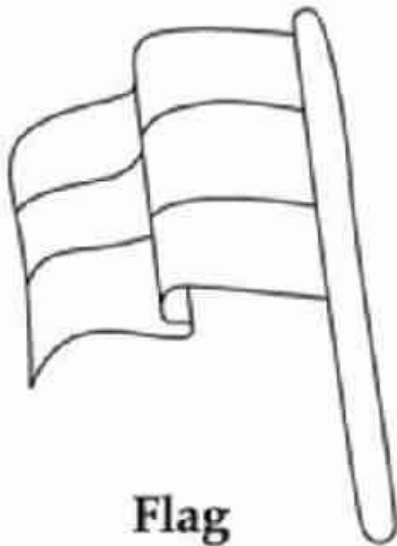

**Flag**



**Frog**

**Rr**

**Rabbit**

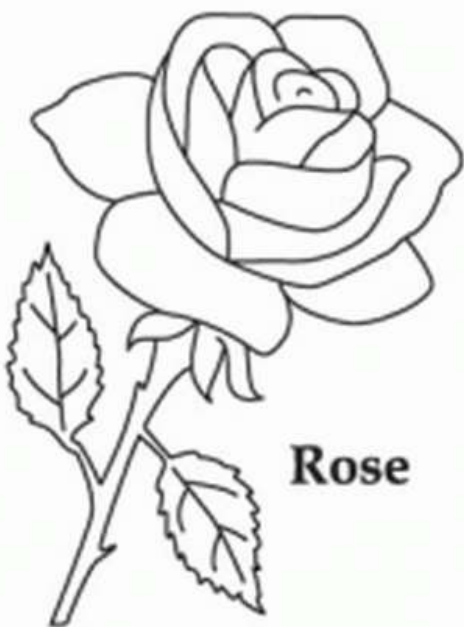

**Rose**

**Rainbow**



**Rectangle**

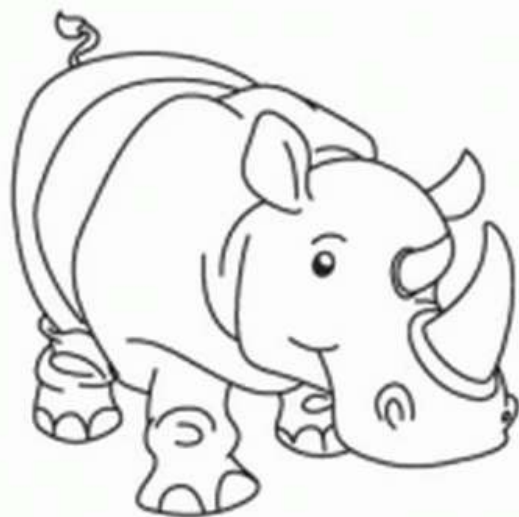

**Rhinoceros**

**Bb**

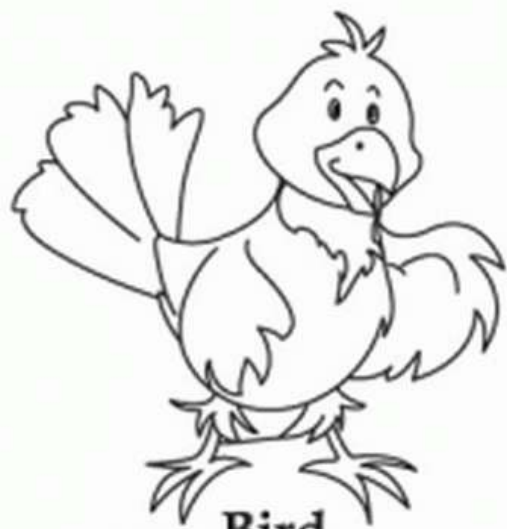

**Bird**

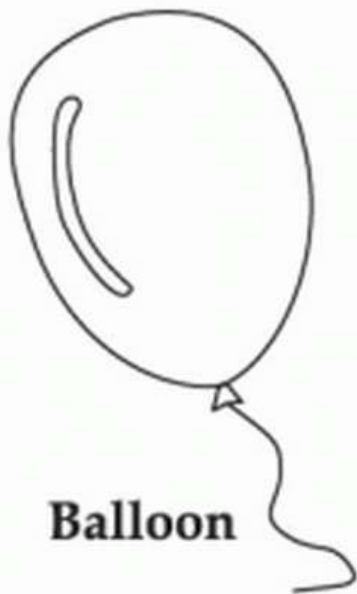

**Balloon**

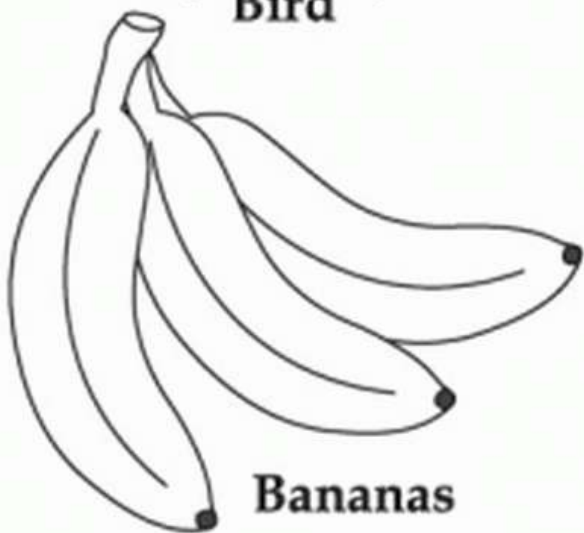

**Bananas**



**Butterfly**



**Bear**

Nn



Nightingale



Nose



Nest



Net

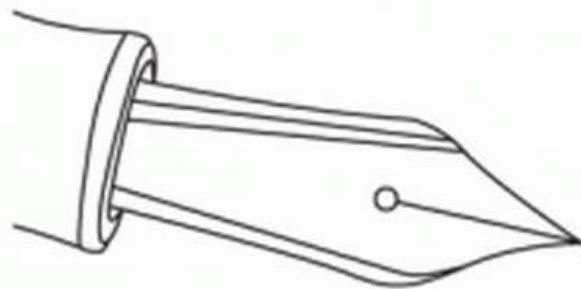

Nib



**Kk**



**Kangaroo**



**Kingfisher**

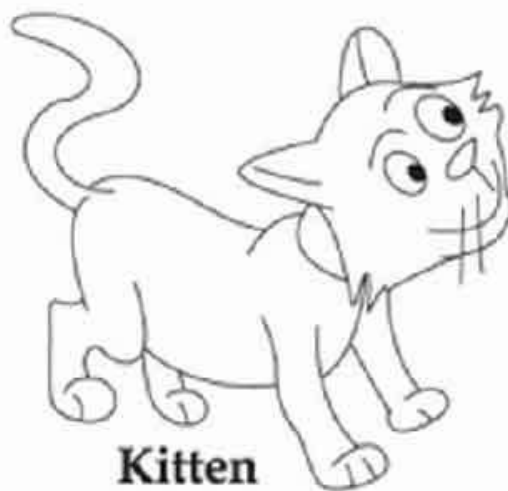

**Kitten**

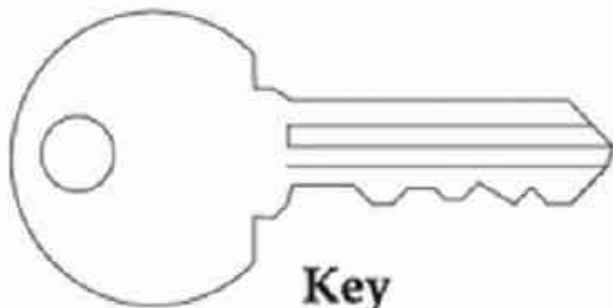

**Key**

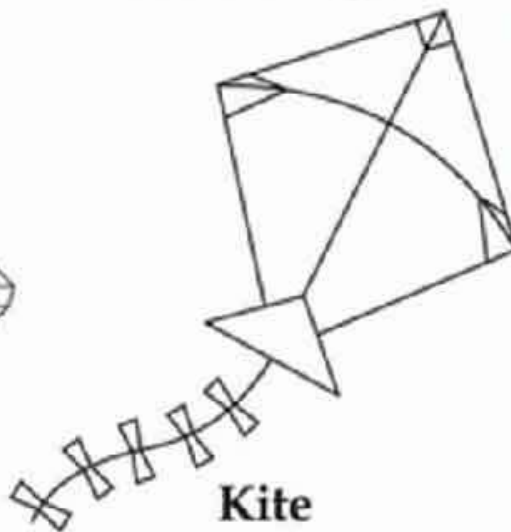

**Kite**



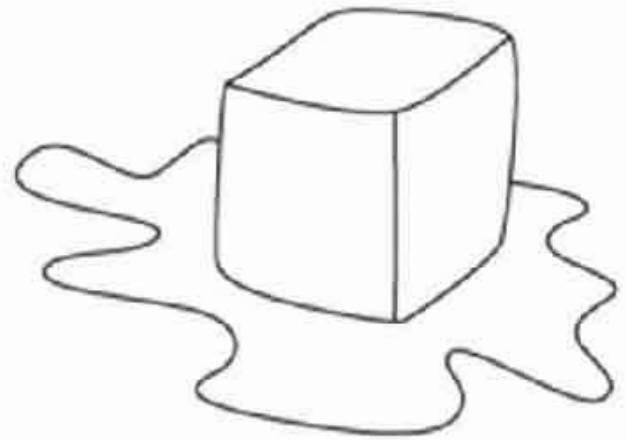

**Ice**



**Ice cream**



**Infant**

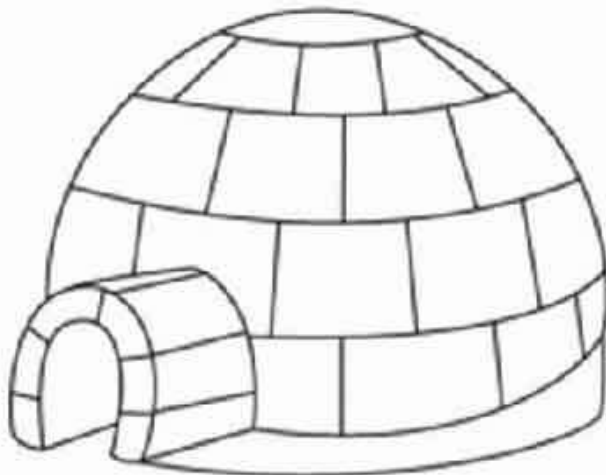

**Igloo**

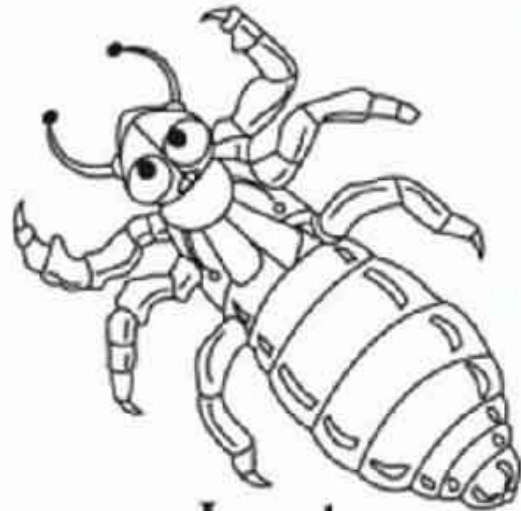

**Insect**

Ss

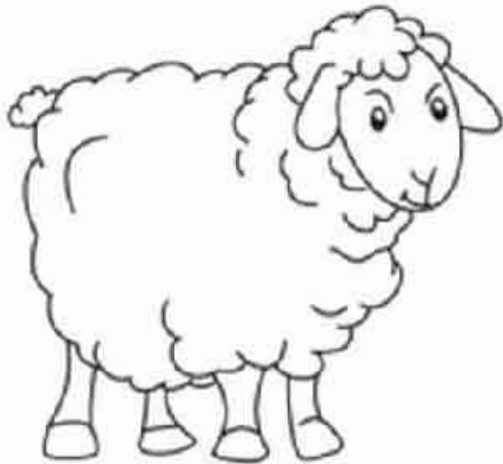

Sheep

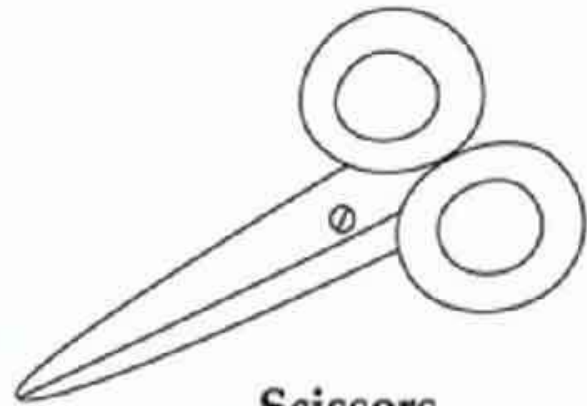

Scissors

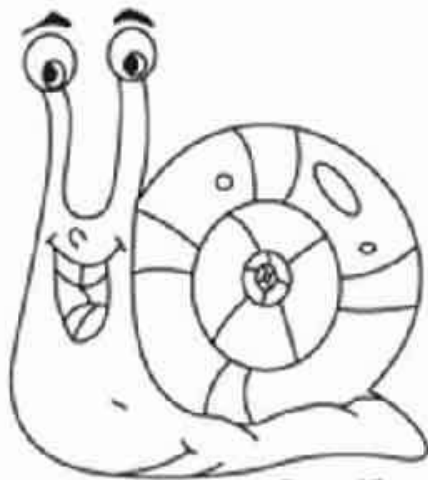

Snail



Shoe

**Ee**

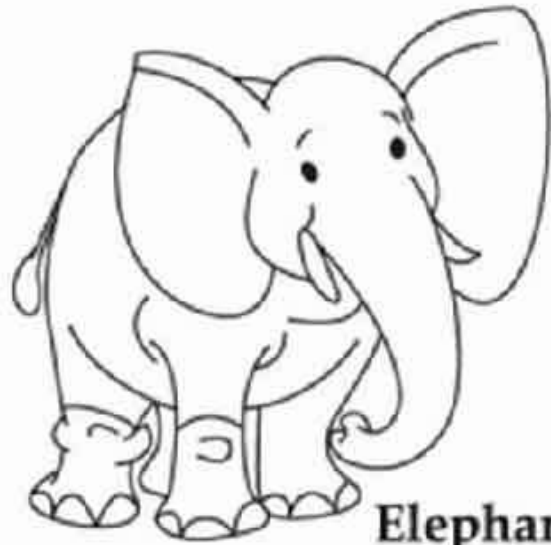

**Elephant**

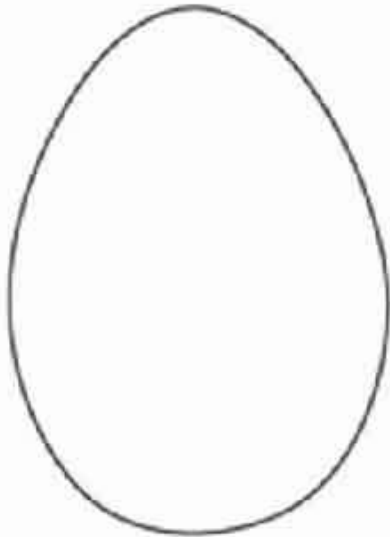

**Egg**

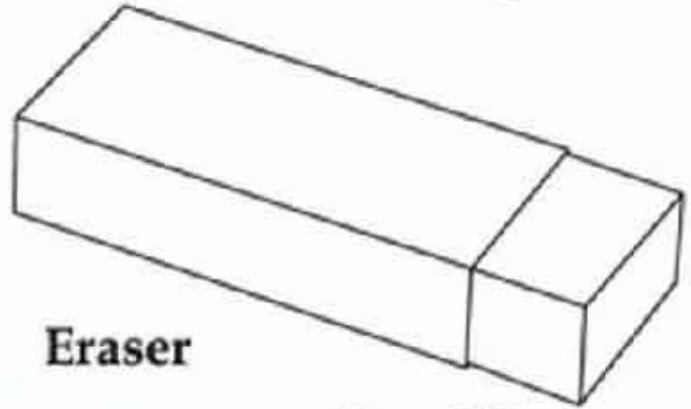

**Eraser**



**Earth**



**Engine**

Hh



Helicopter



Hen



Hat

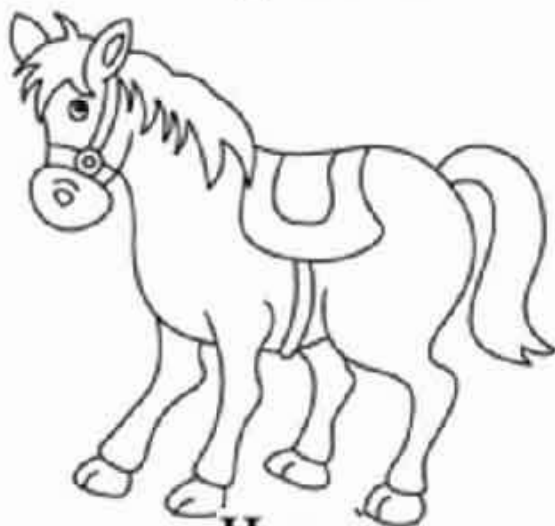

Horse



House

V v

Vase

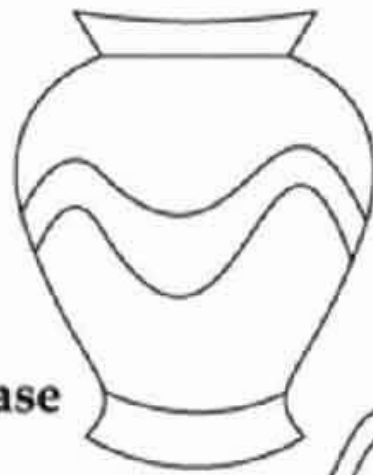

Vulture

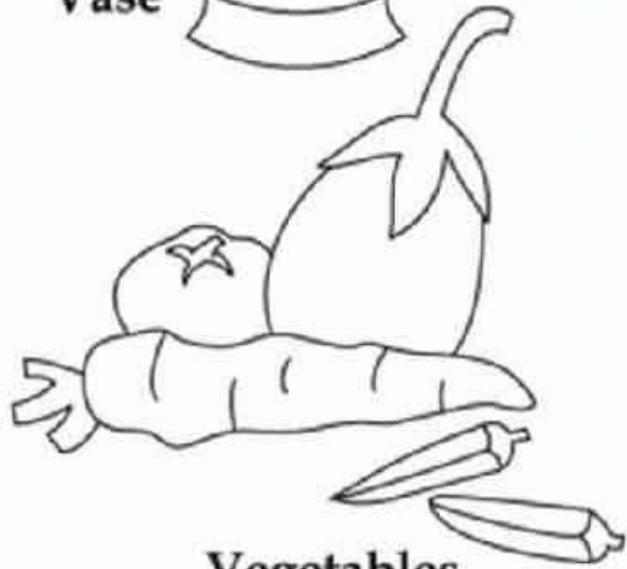

Vegetables

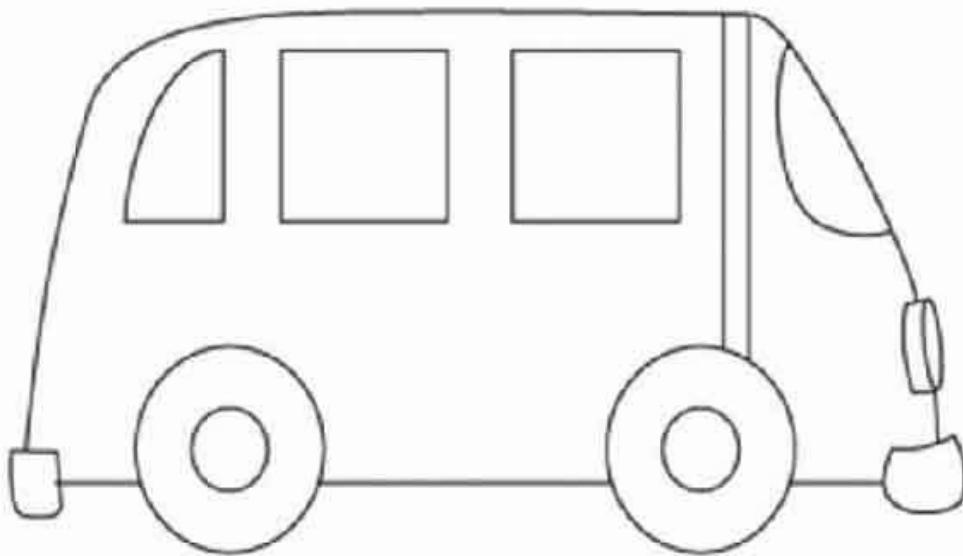

Van

L I



Lion



Leaf

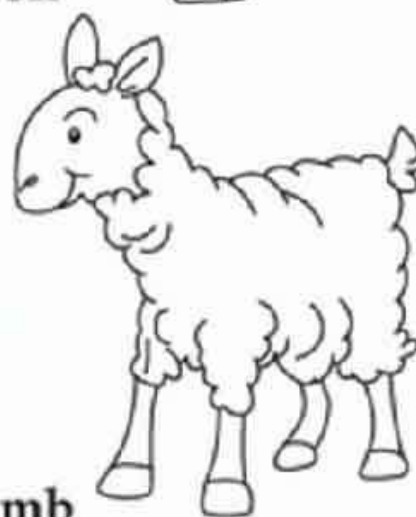

Lamb



Lobster

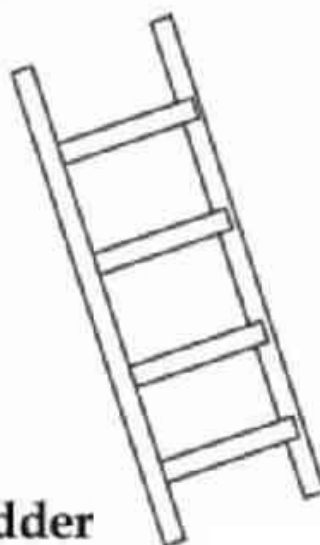

Ladder



Q q

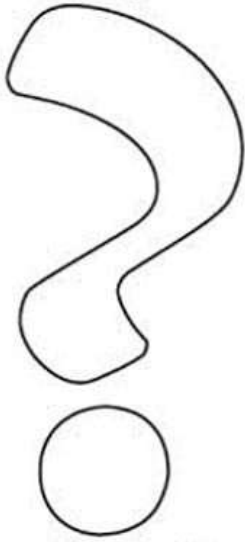

Question Mark

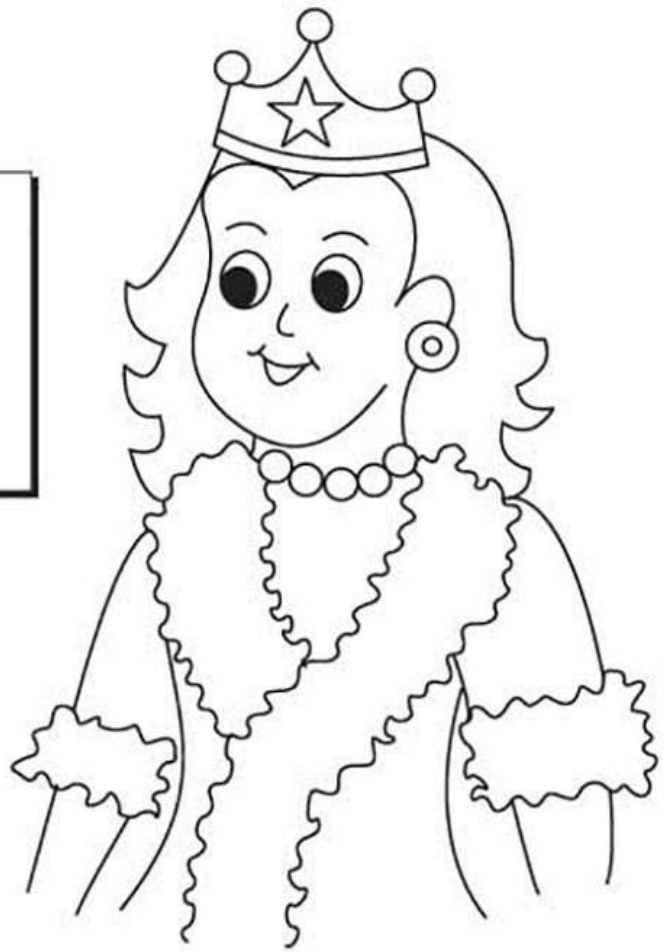

Queen

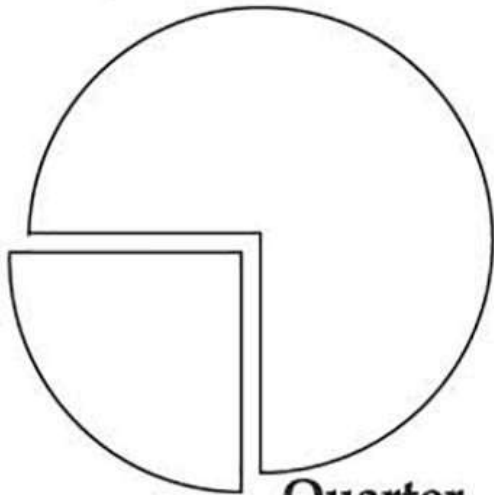

Quarter

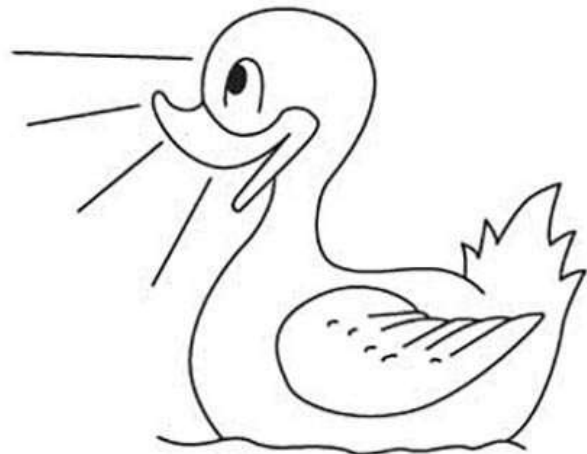

Quack

**Xx**

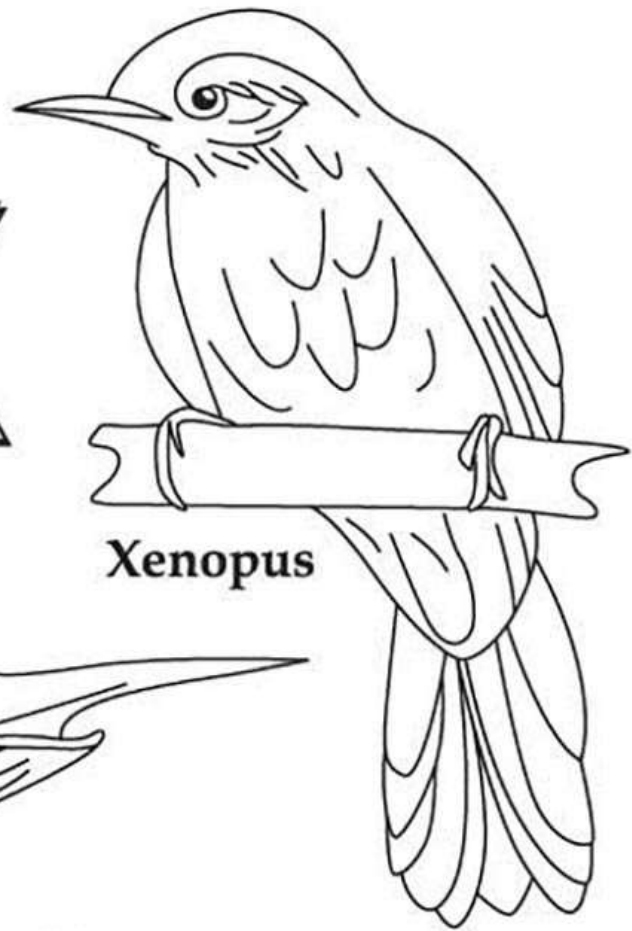

**Xenopus**

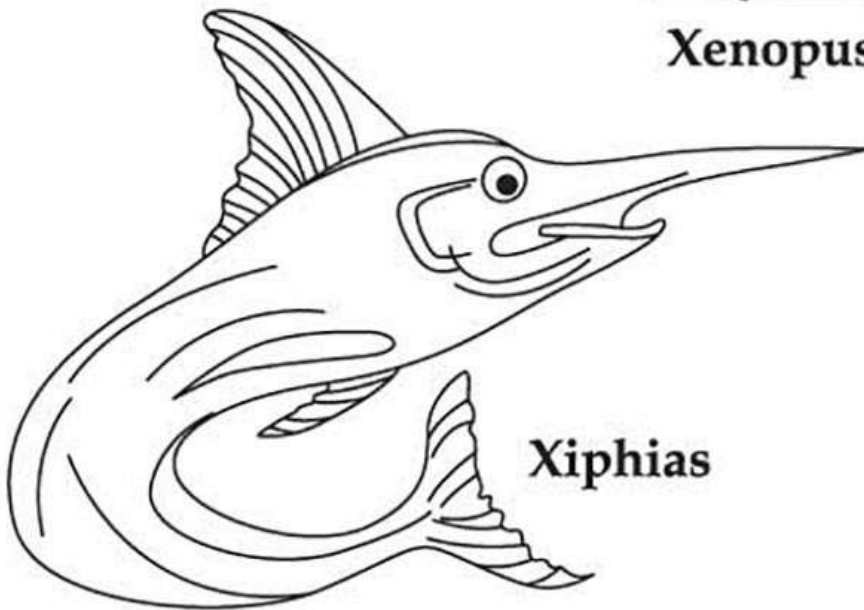

**Xiphias**

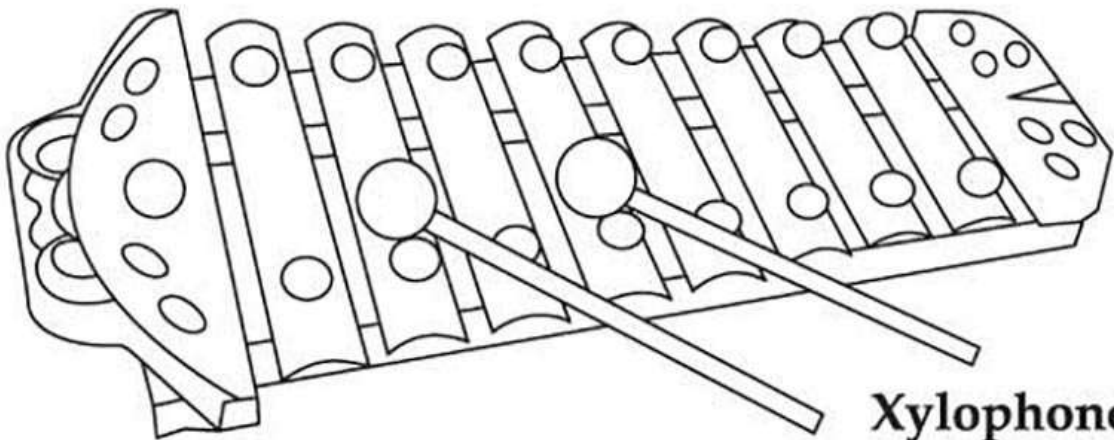

**Xylophone**

Ww

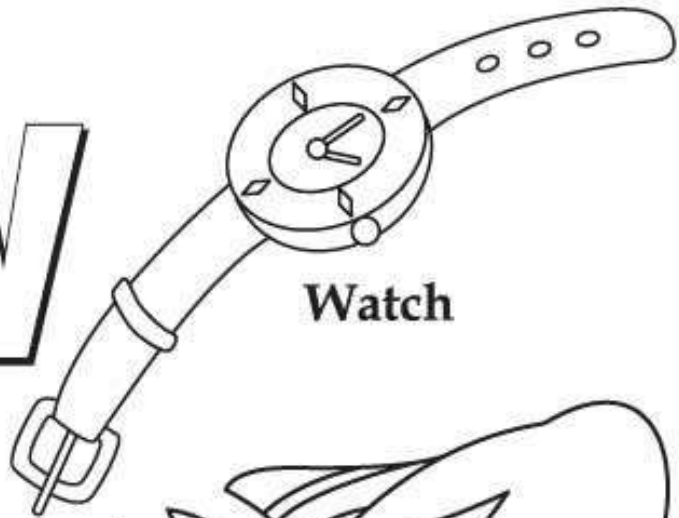

Watch

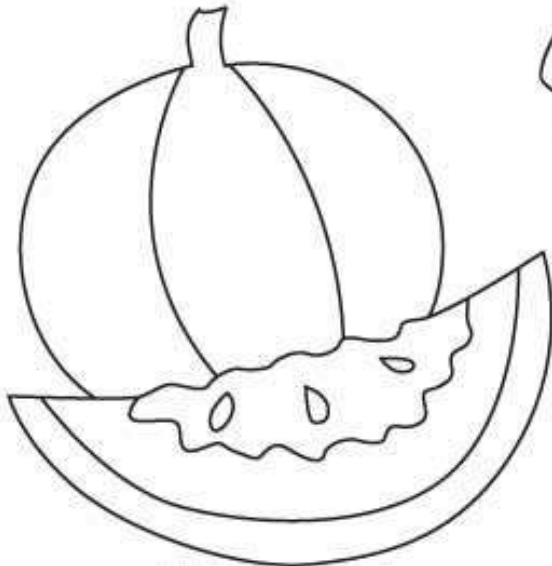

Watermelon

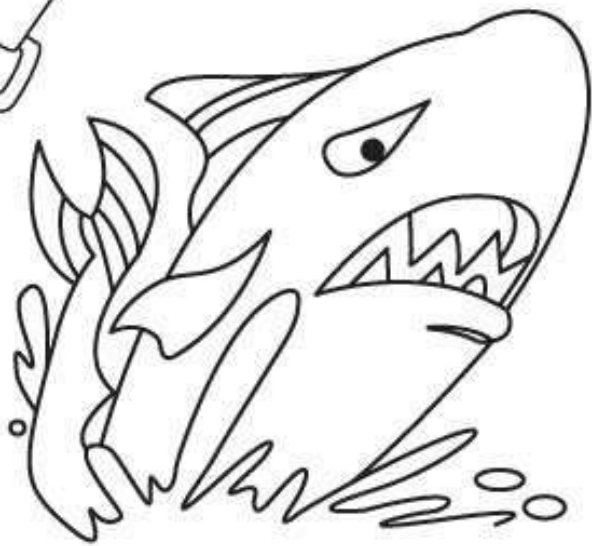

Whale

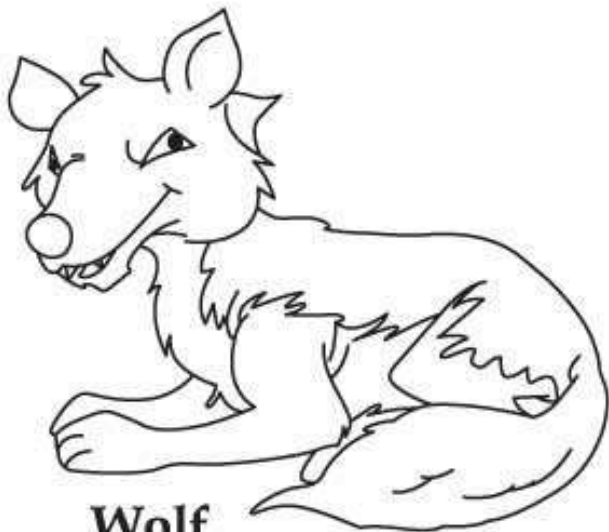

Wolf

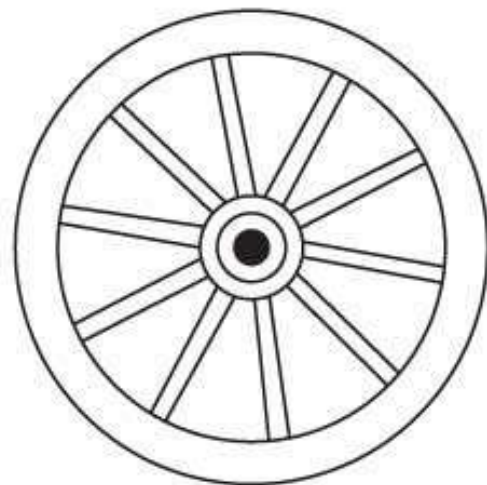

Wheel

## 2. Цвета



white



black



red



yellow

детский  
ЧУДО  
ЮДО  
набор



grey



orange



green



blue



w\_i\_e



g\_e\_n



y\_l\_o\_



b\_u\_



b\_a\_k



r\_d



o\_a\_g\_



g\_e\_

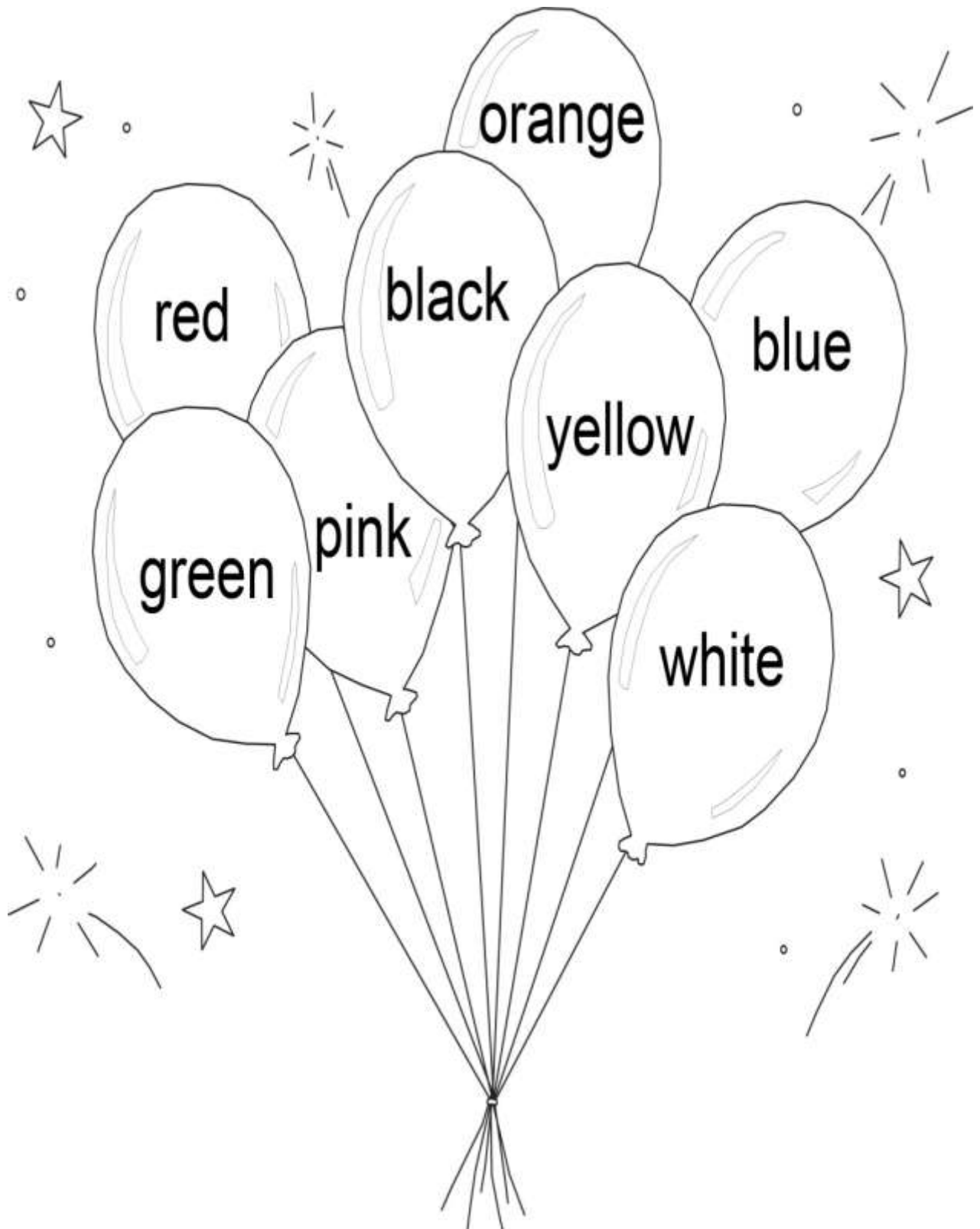

orange

red

black

blue

yellow

green

pink

white



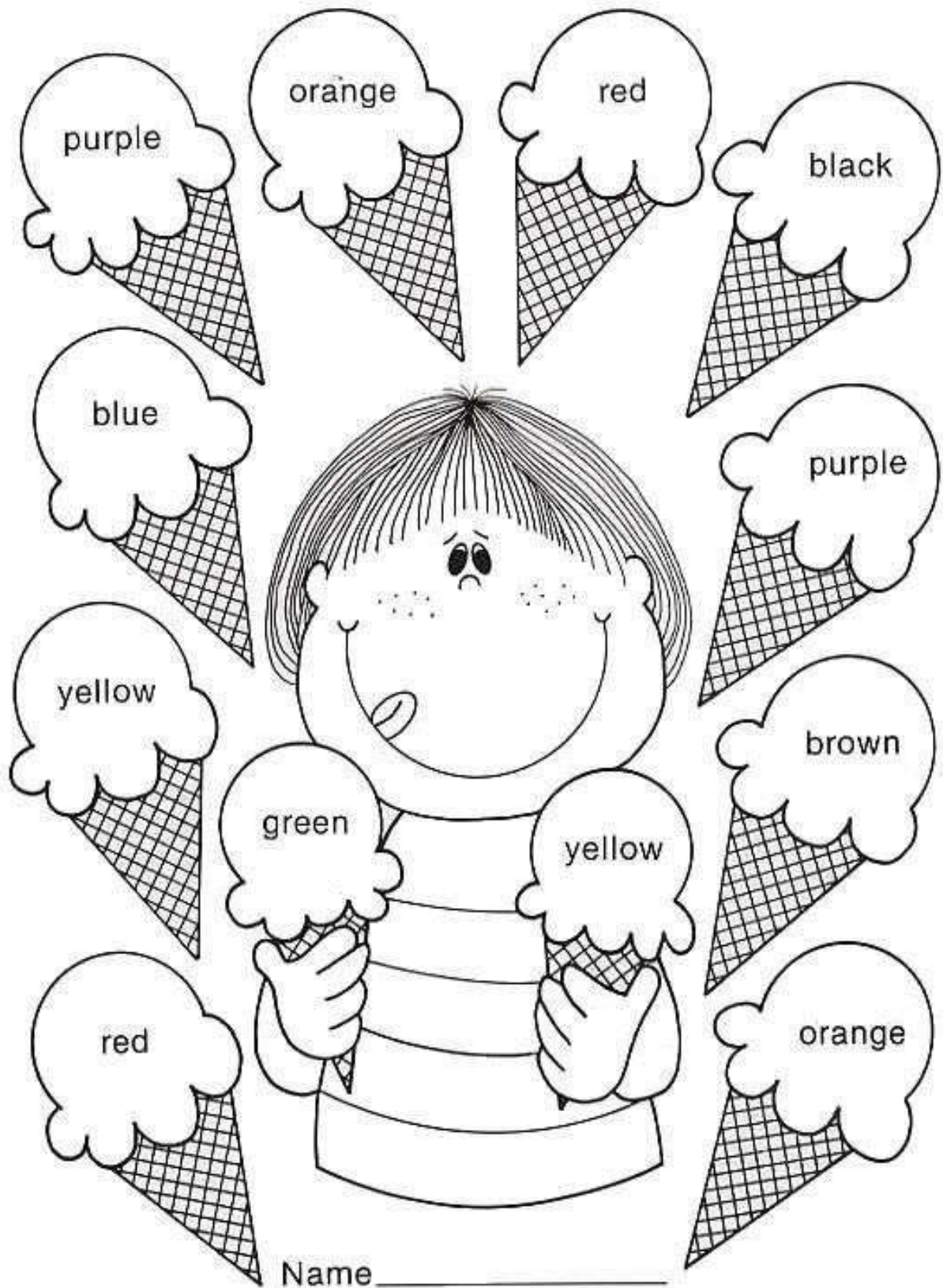



### 3. Моя семья

brother    grandma    grandpa    aunt  
uncle    father    grandmother  
mother    grandfather    sister



\_\_\_\_\_

\_\_\_\_\_

\_\_\_\_\_

\_\_\_\_\_

\_\_\_\_\_

\_\_\_\_\_

\_\_\_\_\_

\_\_\_\_\_



## FAMILY

1



\_\_\_\_\_

2



\_\_\_\_\_

3



\_\_\_\_\_

4



\_\_\_\_\_

5



\_\_\_\_\_

6



\_\_\_\_\_

# MY FAMILY



DAD



SISTER



MOM



BROTHER



## 4. Праздники

Name: \_\_\_\_\_

# COLOR MY VALENTINE!

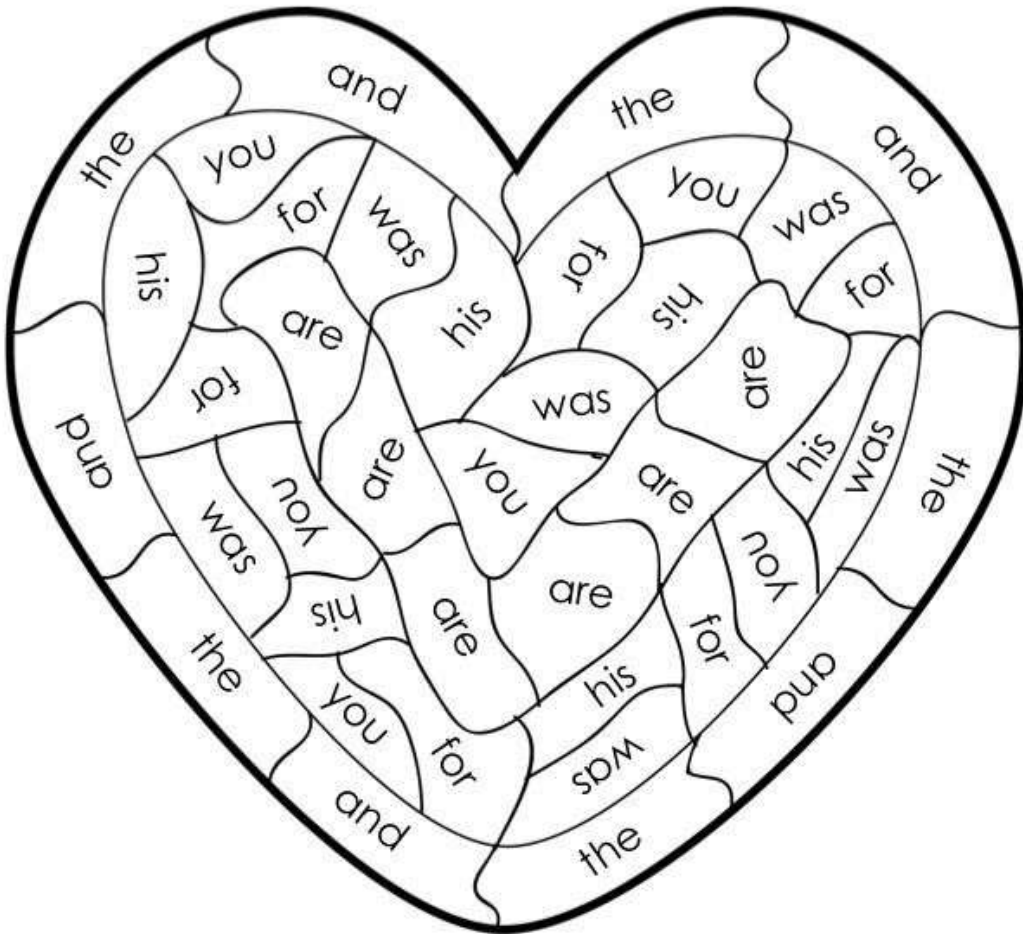

Find each word in the heart and color the space using the key below.

**you:** purple  
**and:** light blue  
**the:** dark blue

**for:** yellow  
**was:** orange

**his:** green  
**are:** pink

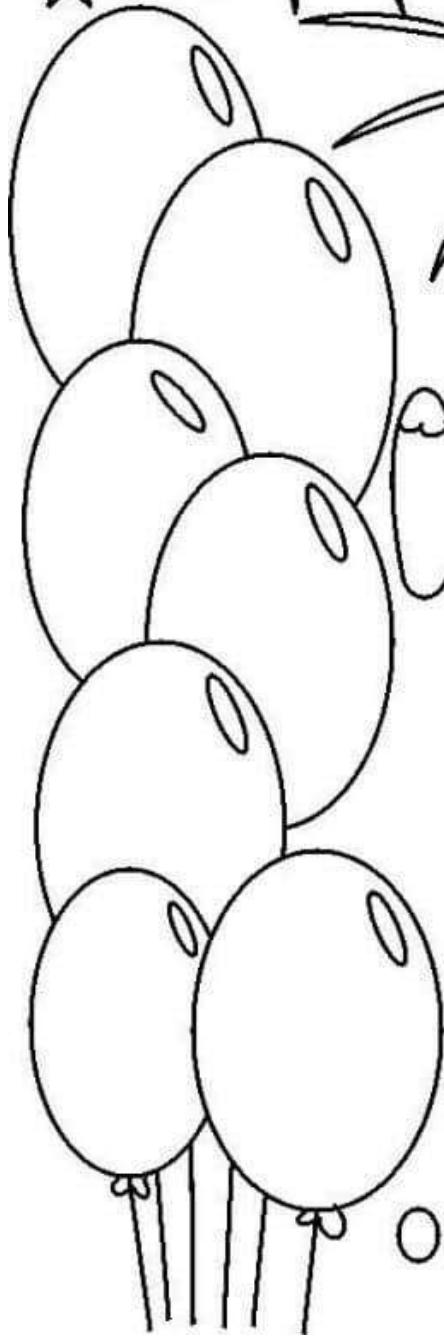
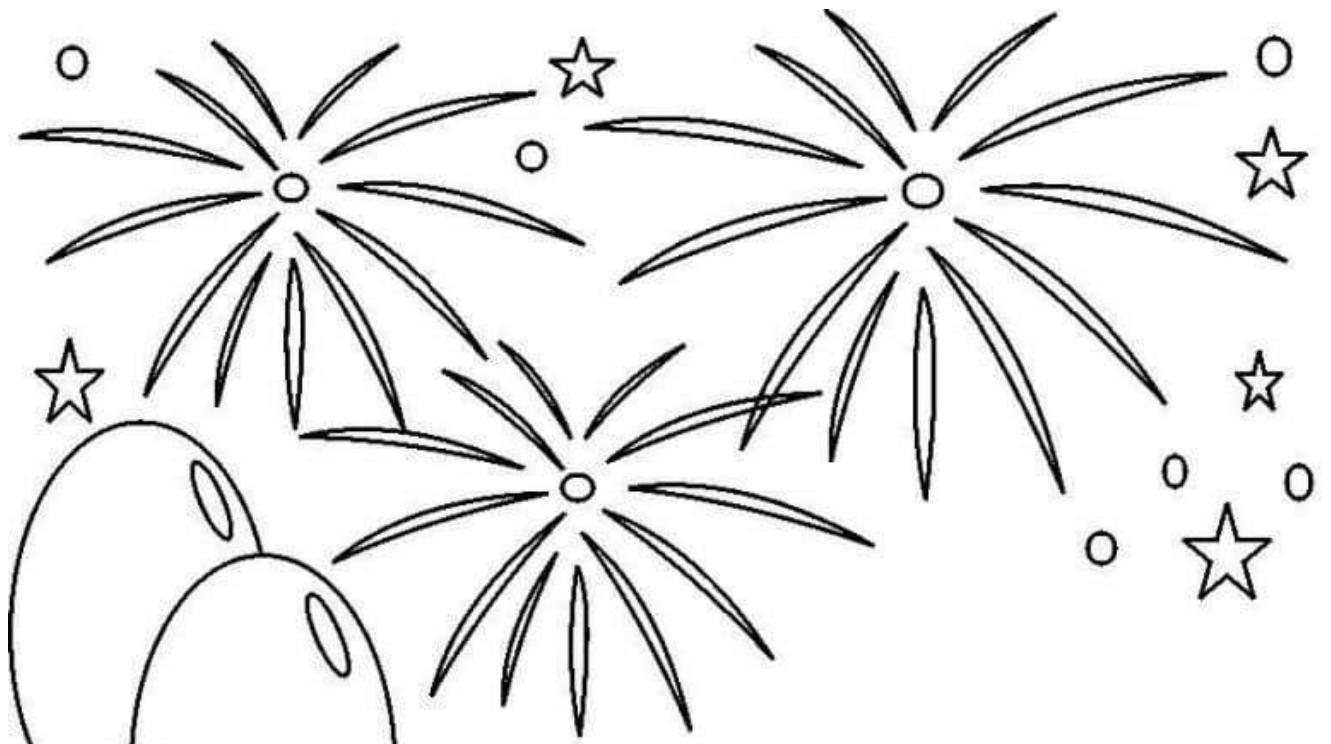

HAPPY  
NEW  
YEAR

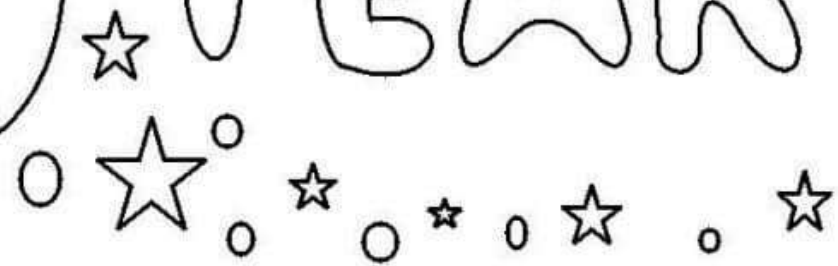



HAPPY  
THANKS  
GIVING





# HAPPY



# Halloween!





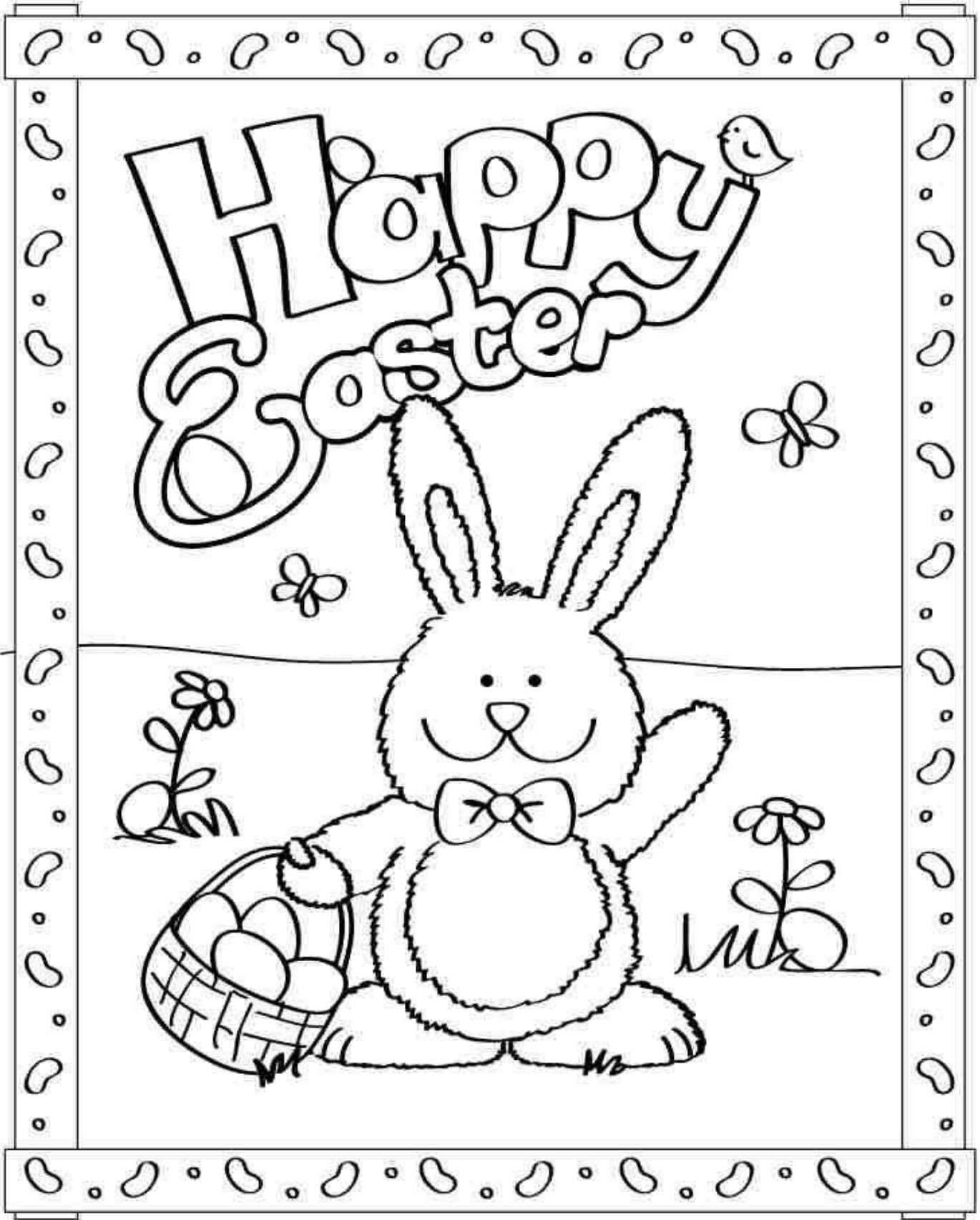



# Happy Halloween



Name

Happy  
St. Patrick's  
Day!

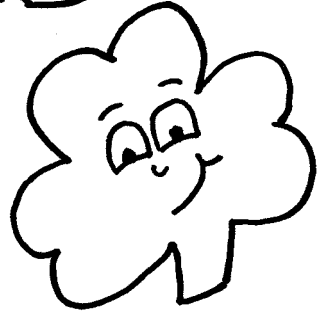
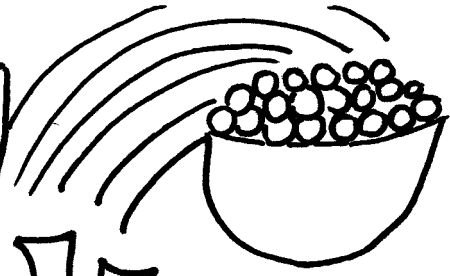

HAPPY  
THANKS  
GIVING

## 5. Времена года

# The Four Seasons

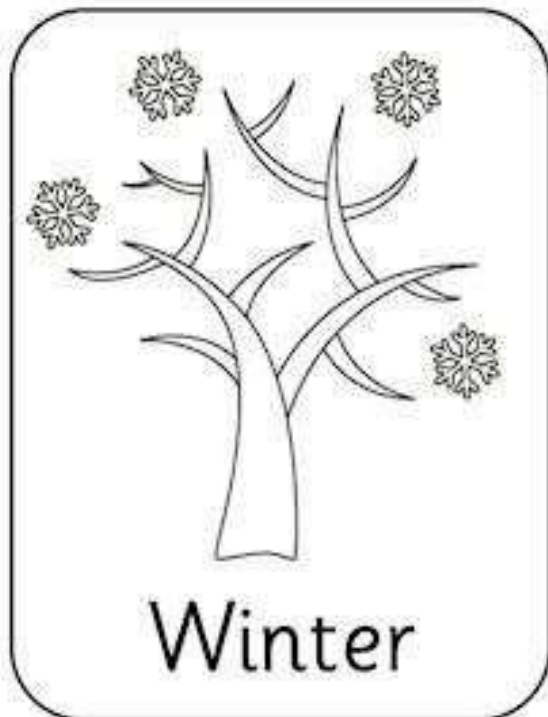
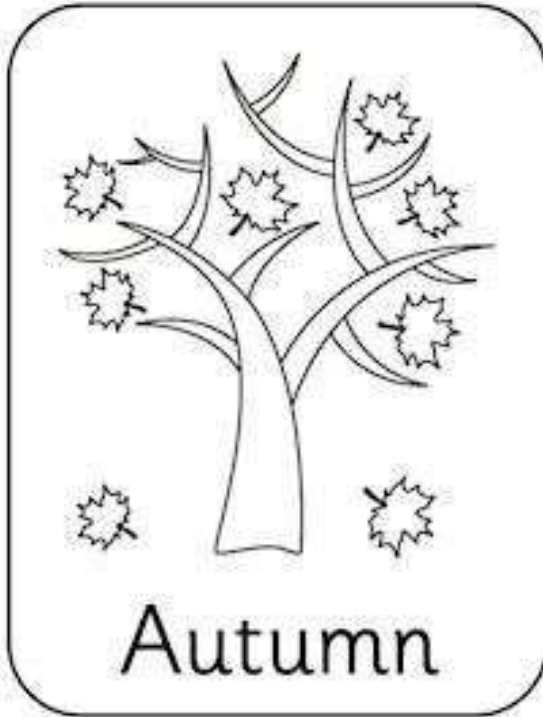

## 6. Одежда

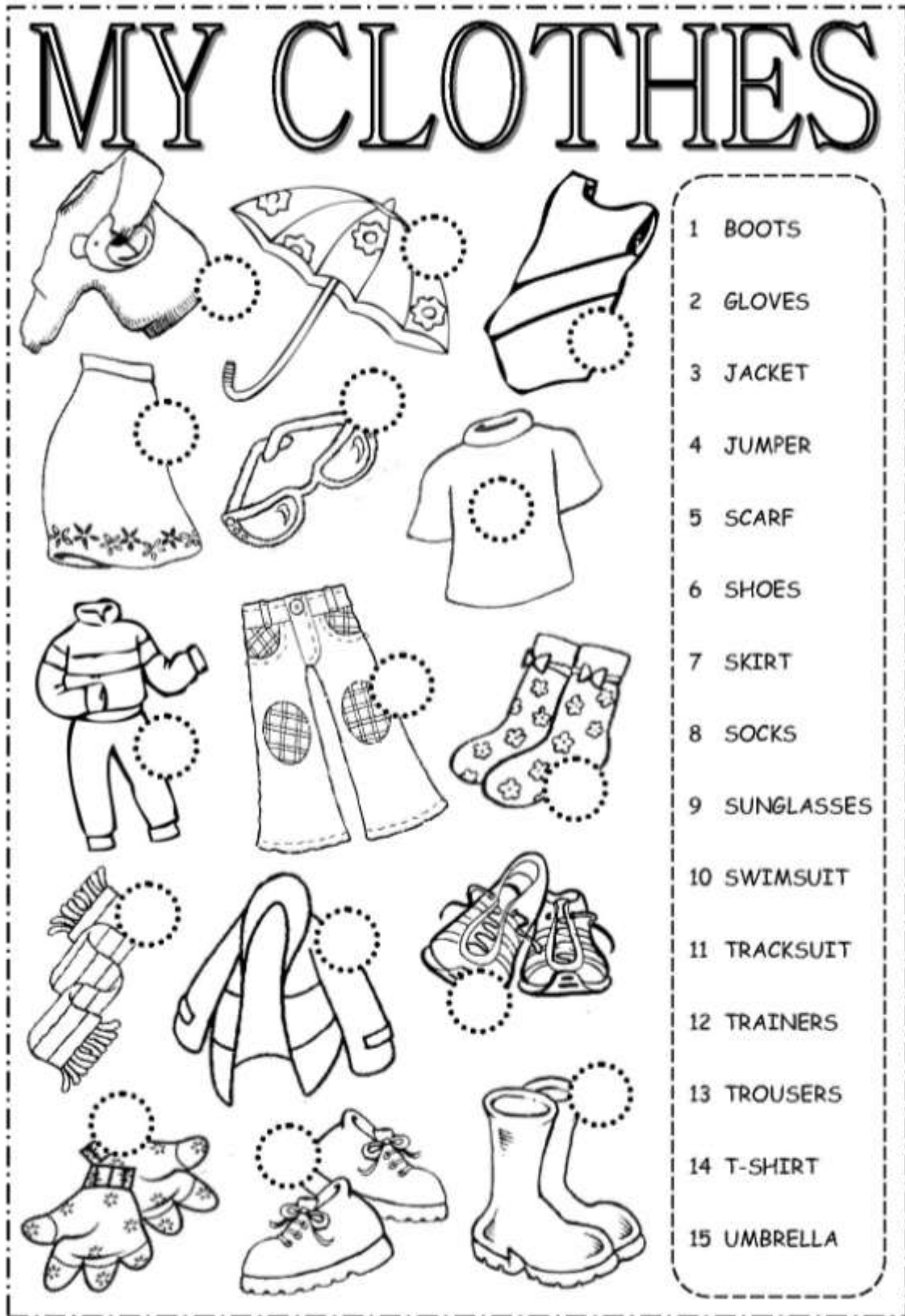

## 7. Цифры



**zero**



**one**



**two**



**three**



**four**



**five**



**six**



**seven**



**eight**



**nine**



**ten**

## 8. Школа

blackboard

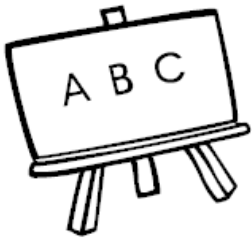

notebook

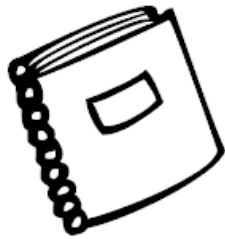

pen



school bag



rubber



ruler

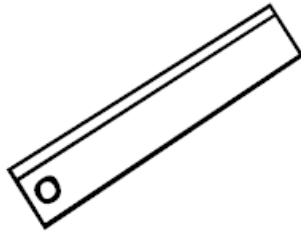

pencil case

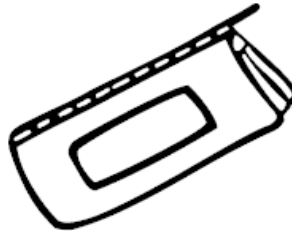

book



pencil

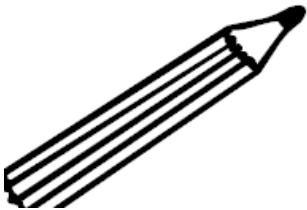

sharpener

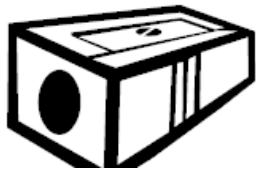

chalk



desk

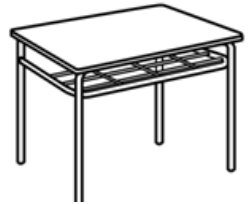



## 9. Животные

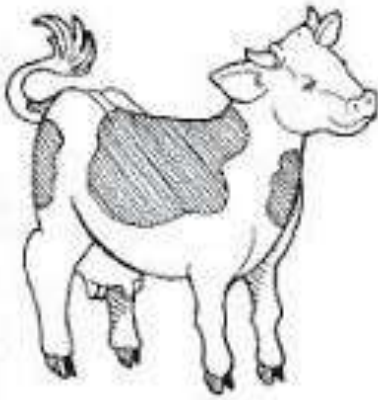

cow



horse



goose

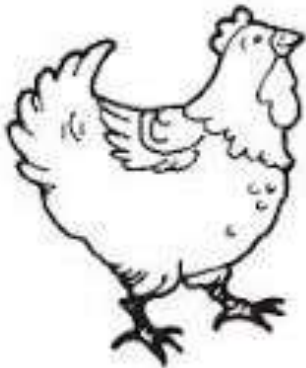

chicken

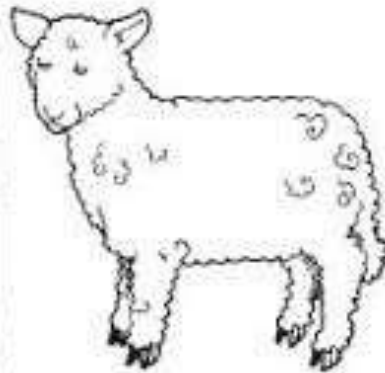

sheep



goat



dog



cat

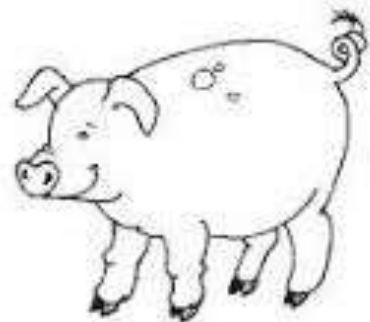

pig

tiger



lion

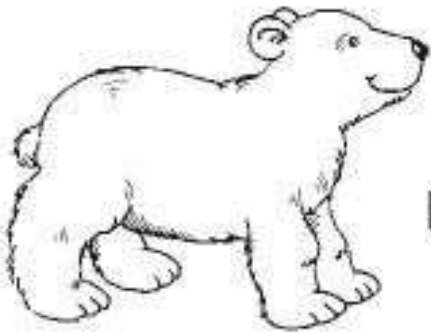
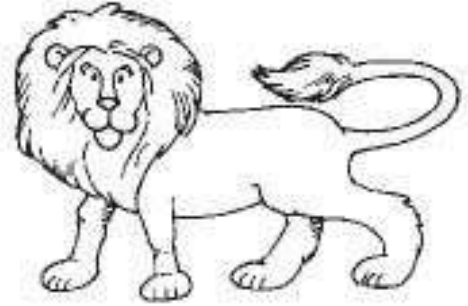

bear

elephant

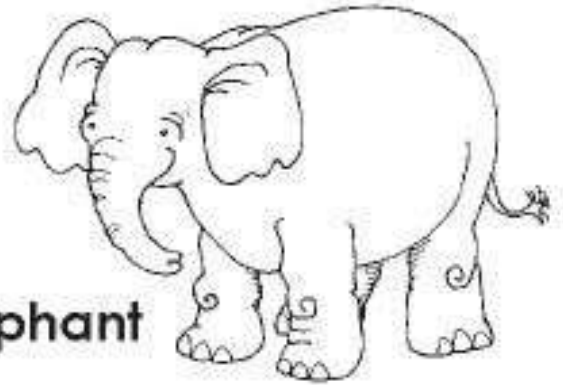

seal

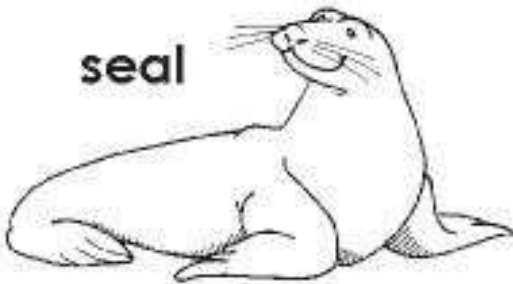

flamingo

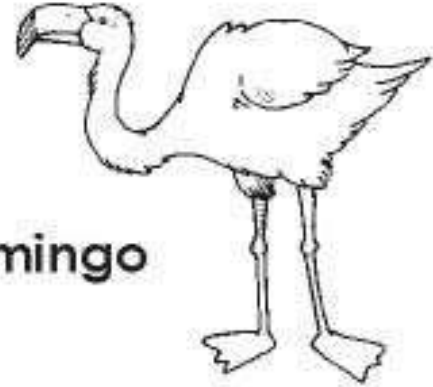

giraffe



chimpanzee



# Home

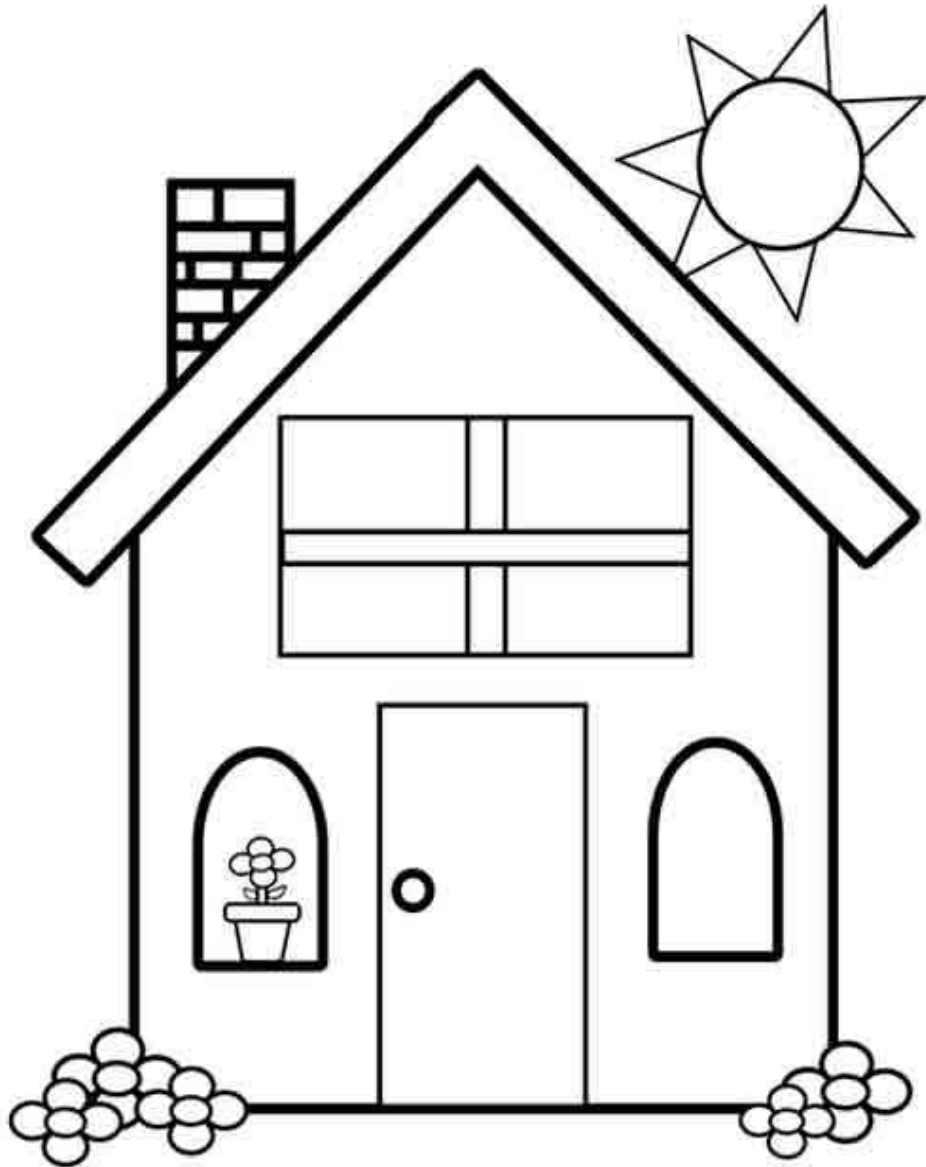

# Our House

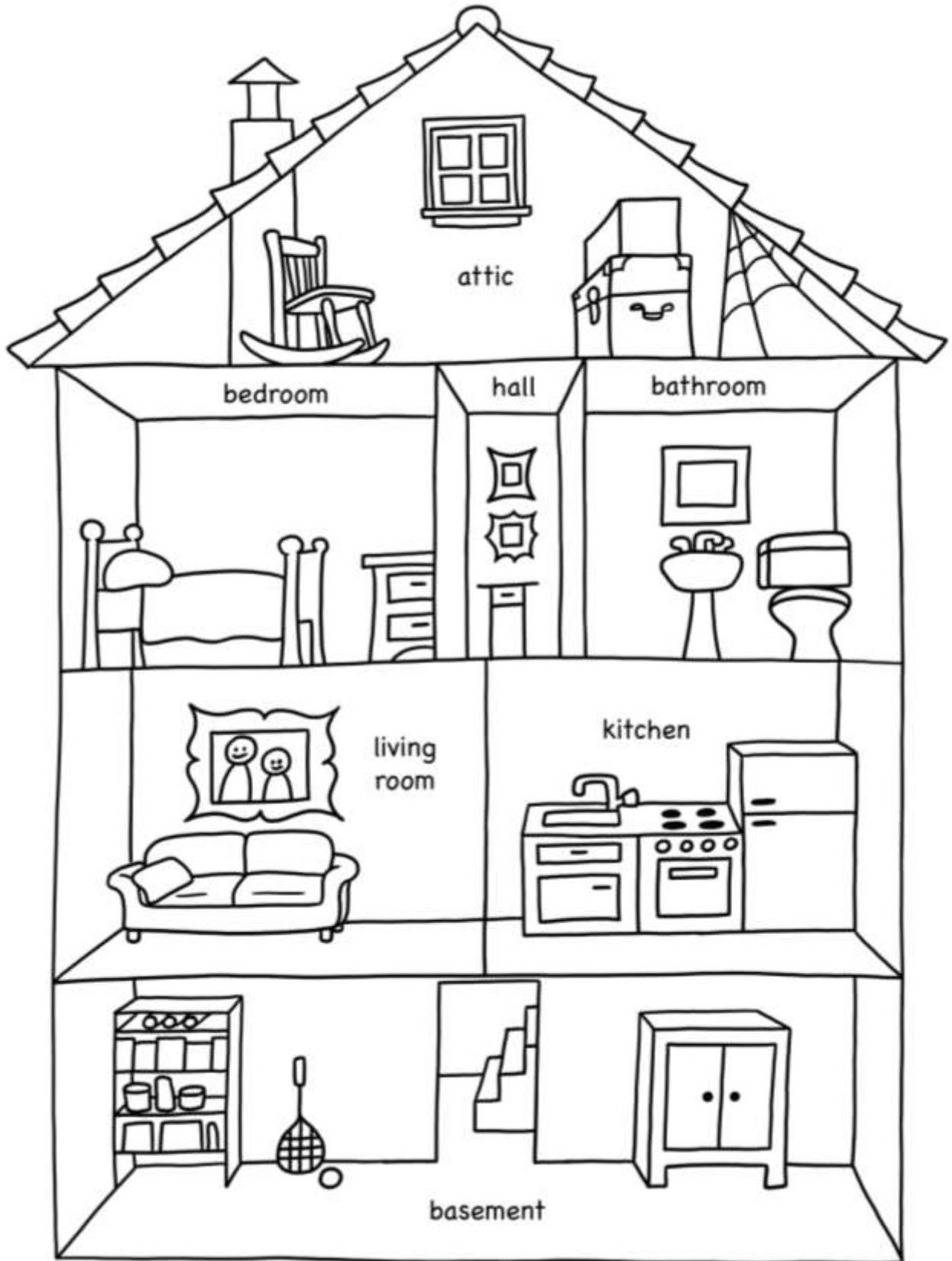

# 11. Хобби и спорт

What do you do in your free time?





Read



Listen to music



Play the guitar



Play football



Play Tennis



Play badminton



Go swimming



Go to the cinema



Watch television



Play board games



Go to the park





## Word Search Puzzle Sports

B	A	S	K	E	T	B	A	L	L
O	J	U	D	O	B	A	S	K	M
X	I	R	O	B	O	S	U	R	G
I	L	F	E	N	S	E	B	C	O
N	O	I	D	A	F	B	C	D	L
G	O	N	A	P	Z	A	Y	K	F
L	F	G	C	Y	C	L	I	N	G
F	O	O	T	B	A	L	L	B	D
D	A	R	T	B	O	A	R	D	K
L	A	W	N	T	E	N	N	I	S



Baseball



Basketball



Boxing



Surfing



Judo



Cycling

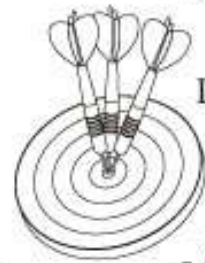

Dartboard



Football



Lawn Tennis



Golf

## 12. Продукты



apple

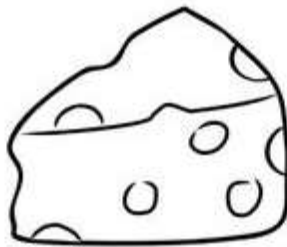

cheese

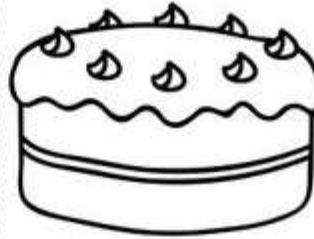

cake

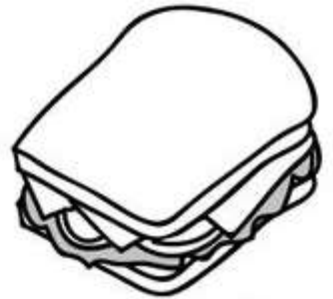

sandwich



french fries

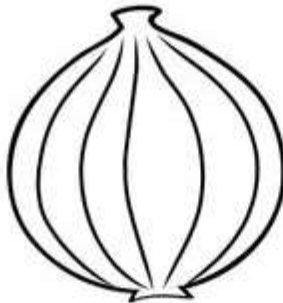

onion

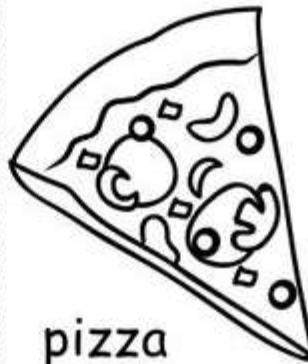

pizza



chicken

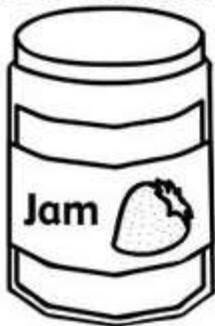

jam



steak

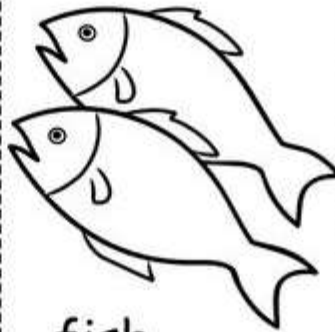

fish



milk

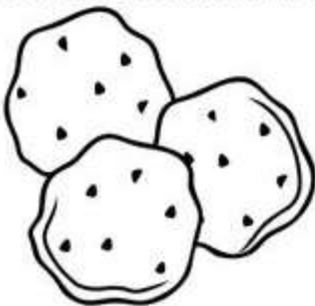

cookies

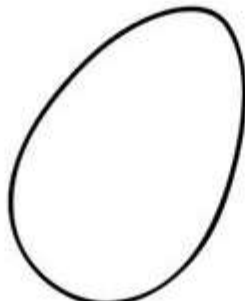

egg

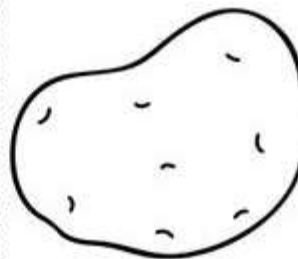

potato

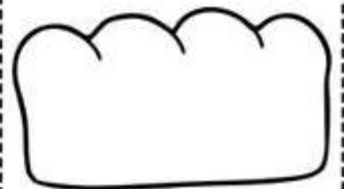

bread

13. Овощи и фрукты

# FRUIT AND VEGETABLES



APPLE

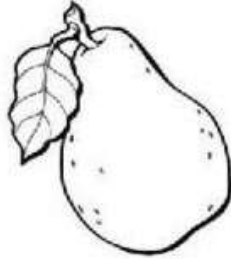

PEAR

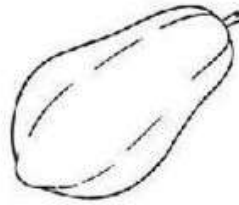

PAPAYA



PLUM

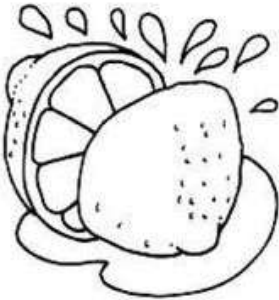

LEMON



MANGO



BANANA



ORANGE

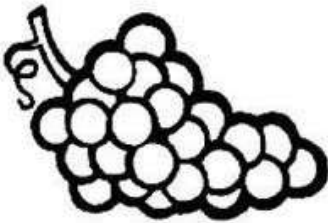

GRAPES

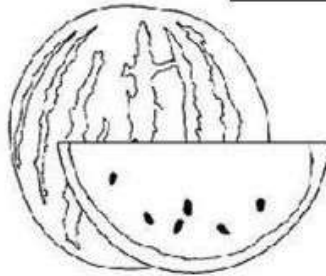

WATERMELON

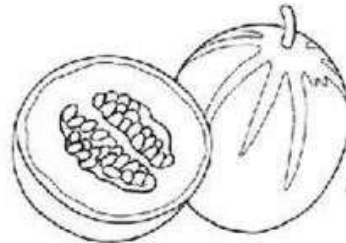

MELON



LETTUCE

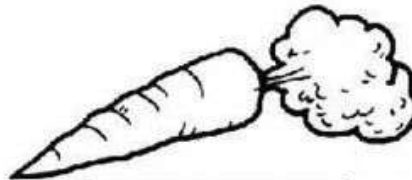

CARROT

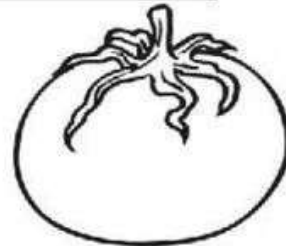

TOMATO

# 14. Транспорт

## Means of transportation

Match

Name \_\_\_\_\_



BIKE



CAR



BOAT

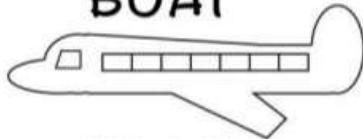

PLANE

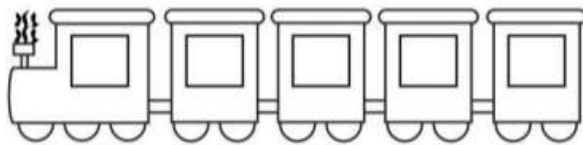

TRAIN



LAND

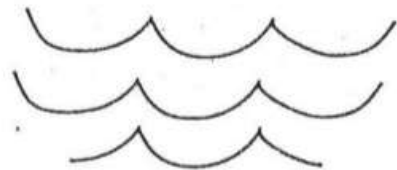

WATER



AIR